

# HEINNER

## AUTOMATIC WASHING MACHINE

Model:

HWM-M914IVKB+++/HWM-M1014IVKB+++



- Automatic washing machine
- Loading capacity: 9/10kg
- Energy class: B







Thank you for purchasing this product!

## I. INTRODUCTION

***Before using the appliance, please read carefully this instruction manual and keep it for future reference.***

This instruction manual is designed to provide you with all required instructions related to the installation, use and maintenance of the appliance.

In order to operate the unit correctly and safety, please read this instruction manual carefully before installation and usage.

Icon	Caption	Description
	WARNING	Risk of serious injury or death
	RISK OF ELECTRIC SHOCK	Dangerous voltage
	FIRE	Risk of fire
	ATTENTION	Risk of injury or material damage
	IMPORTANT/NOTE	Information on correct operation of the system
		Read the instructions
		Hot surface

## II. CONTENT OF YOUR PACKAGE



- Automatic washing machine
- User manual
- Warranty card

### III. SAFETY PRECAUTIONS

The product is intended only for home use and for textiles in household amounts suitable for washing. This appliance is for indoor use only and not intended for built in use. Only use according to these instructions. The appliance is not intended for commercial use.

Any other use is considered as improper use. The producer is not responsible for any damage or injury that may result from it.

This appliance is intended to be used in household and similar applications such as:

- Staff kitchen areas in shops, offices and other working environments;
- Farm houses;
- By clients in hotels, motels and other residential type environments;
- Bed and breakfast type environments;
- Areas for communal use in blocks of flats or in laundrettes.

#### **WARNING: Electric shock hazard**

- If the supply cord is damaged, it must be replaced by the manufacturer, its service agent or similarly qualified persons in order to avoid a hazard.
- If the machine is damaged, it must not be operated unless repaired by the manufacturer, its service agent or similarly qualified persons.
- Risk of electric shock!
- The appliance can be used by children aged from 8 years and above and persons with reduced physical, sensory or mental capabilities or lack of experience and knowledge if they have been given supervision or instruction concerning use of the appliance in a safe way and understand the hazards involved. Children shall not play with the appliance. Cleaning and user maintenance shall not be made by children without supervision.
- Children should be supervised that they do not play with the appliance.
- Children 3 years and under shall be kept away from the appliance or continuously supervised.
- Animals and children may climb into the machine. Check the machine before every operation.
- Do not climb or sit on the appliance

#### **Installation Location and Surrounding**

- All washing and additional substances are to be kept in a safe place out of the reach of children.
- Do not install the machine on a carpet floor.
- The obstruction of the openings by a carpet can damage the machine.
- Keep the appliance clear from heating sources and direct sunlight to avoid plastic and rubber parts to corrode.

- Do not use the appliance in humid environments or rooms containing explosive or caustic gas. In case of water leakage or water splashes, let the appliance dry in the open air.
- The appliance must not be installed behind a lockable door, a sliding door or a door with a hinge on the opposite side to that of the machine .
- Do not operate the machine in rooms with a temperature of below 5°C. This can cause damages to parts of it. If it is unavoidable, make sure to drain the water completely from the appliance after every use to avoid damages caused by frost.
- Never use flammable sprays or substances in the immediate proximity of the appliance.

### **Installation**

- Remove all packaging material and transport bolts before using the appliance. Otherwise, serious damage may result.
- This appliance is equipped with a single inlet valve and can be connected to the cold water supply only.
- Mains plug must be accessible after installation.
- Before washing clothes for the first time, the product shall be operated once throughout all the procedures without any clothes inside.
- Before using the machine, the product shall be calibrated.
- Do not put any excessively heavy objects on the appliance, like water containers or heating devices.
- The new hose-sets supplied with the appliance are to be used and that old hose-sets should not be reused.
- Max. Inlet water pressure 1 MPa. Min. inlet water pressure 0.05 MPa.

### **Electrical Connection**

- Make sure the supply cable is not trapped by the machine, or it can get damaged.
- Connect the product to a grounded outlet protected by a fuse complying with the values in the "Technical specifications" table. The grounding installation has to be made by a qualified electrician. Ensure that the machine is installed in accordance with the local regulations.
- Water and electrical connections must be carried out by a qualified technician in accordance with the manufacturer's instructions and local safety regulations.

### **WARNING**

- Don't use multiple plugs or extension cords.
- The appliance must not have an external switching device such as a timer or connected to a circuit that is regularly switched on and off.
- Do not pull the plug out of the mains outlet if there is flammable gas around.
- Never pull out power plug with wet hands.
- Always pull at the plug, not at the cable.
- Always unplug the appliance if it is not being used.

### **Water Connections**

- Check the connections of the water inlet tubes, the water tap and the outlet hose for possible problems due to changes of water pressure. If the connections loosen or leak, close the water tap and get it repaired.
- Do not use the appliance before the pipes and hoses are installed properly by qualified persons.
- Glass door may become very hot during the operation. Keep children and pets far away from the machine while it is operating.

- The water inlet and outlet hoses have to be safely installed and remain undamaged.
- Otherwise, water leakage can occur.
- Do not remove the drain pump filter while there is still water in the appliance. Big quantities of water can leak out, and there is a risk of scalding due to hot water.

### **Operation and Maintenance**

- Never use any flammable, explosive or toxic solvents. Do not use gasoline and alcohol etc. as detergents. Only select detergents that are suitable for machine washing.
- Make sure that all pockets are emptied. Sharp and rigid items such as coins, brooches, nails, screws, stones etc. may cause serious damages to this machine.
- Remove all objects from pockets such as lighters and matches before use the appliance. Thoroughly rinse items that have been washed by hand.
- Items that have been soiled with substances such as cooking oil, acetone, alcohol, petrol, kerosene, spot removers, turpentine, wax and wax removers should be washed in hot with an extra amount of detergent before being dried in the appliance.
- Items containing foam rubber (latex foam), shower caps, water proof textiles, rubber backed articles and clothes or pillows fitted with foam rubber pads should not be washed in the machine.
- Fabric softeners or similar products should be used as recommended in their instructions.
- Never try to open the door forcefully.
- The door will unlock shortly after the end of a cycle.
- Please do not close the door with excessive force. If it is found difficult to close the door, please check if the clothes are properly inserted and distributed.
- Always unplug the appliance and close the water tap before cleaning and maintenance and after each use.
- Never pour water over the appliance for cleaning purpose. Risk of electric shock!
- Repairs shall only be carried out by the manufacturer, its service agent or similarly qualified persons in order to avoid a hazard.
- The producer will not be responsible for damages caused by the intervention of not authorized persons.

### **Transport**

- Before Transport:
  - Bolts shall be reinstalled to the machine by a specialized person;
  - Accumulated water shall be drained out of the machine.
- This appliance is heavy. Transport with care.  
Never hold any protruding part of the machine when lifting. The machine door can not be used as a handle.

## IV. INSTALLATION

### Installation Area

#### WARNING

- Stability is important to prevent the product from wandering!
- Make sure the machine is standing leveled and stable .
- Make sure that the product does not stand onto the power cord.
- Make sure to maintain the minimum distances from the walls as shown in the picture.

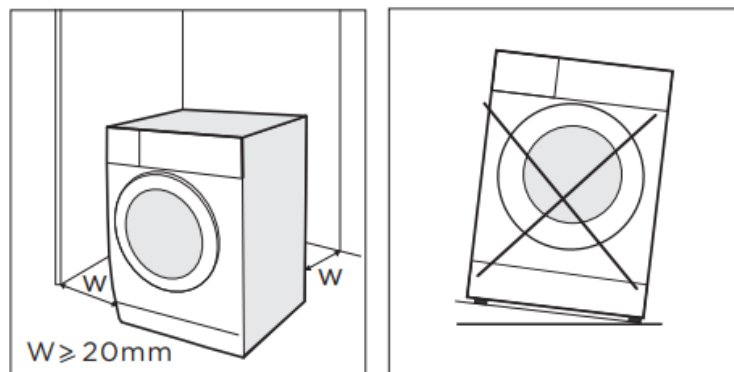

Before installing the machine, the location characterized as follows shall be selected:

1. Rigid, dry, and level surface.
2. Avoid direct sunlight.
3. Sufficient ventilation.
4. Room temperature is above 5 °C .
5. Keep far away from the heat sources such as coal or gas burning appliances

#### Levelling the Machine

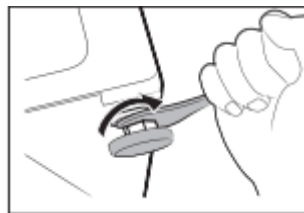

The lock nuts on all four feet must be screwed tightly against the housing

1. Loosen the lock nut.
2. Turn the foot until it reaches the floor.
3. Adjust the legs and lock the nuts with a spanner. Make sure the machine is level using a spirit level.

### Remove Transport Bolts

You must remove the transport bolts from the backside before using the product.

1. Loosen the 4 transport bolts with a spanner.



2. Remove the bolts including the rubber parts and keep them for future use.

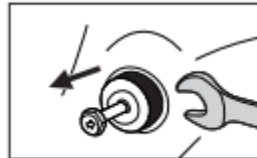

3. Close the holes using the cover caps.

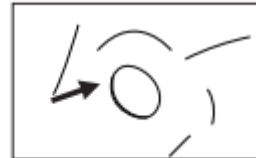

### Connect the Water Supply Hose

To prevent leakage or water damage, follow the instructions in this chapter. • Do not kink, crush or modify water inlet hose



Connect the water supply hose to the water inlet valve and a water tap with cold water as indicated.

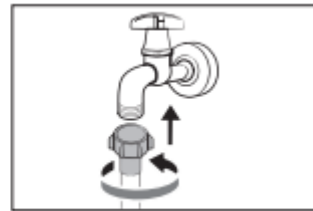

### Drain Hose

- Do not kink or protract the drain hose
- Position drain hose properly ,otherwise damage might result in water leakage.
- It is not allowed to remove the buckle of drain pipe.

There are two ways to place the end of drain hose:

1. Put it into the water trough.

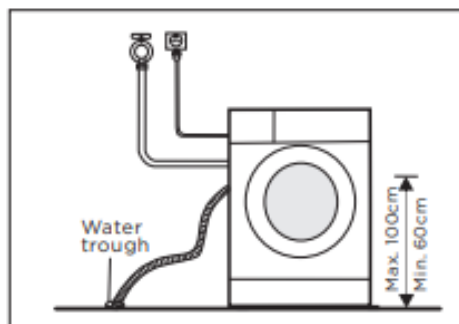

2. Connect it to the branch drain pipe of the trough.

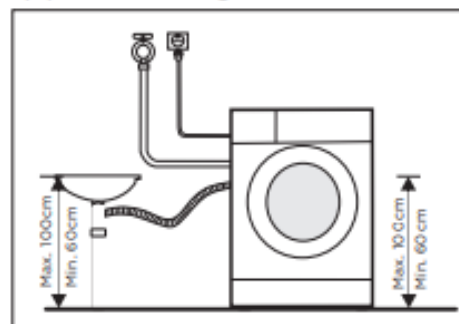

V. PRODUCT DESCRIPTION

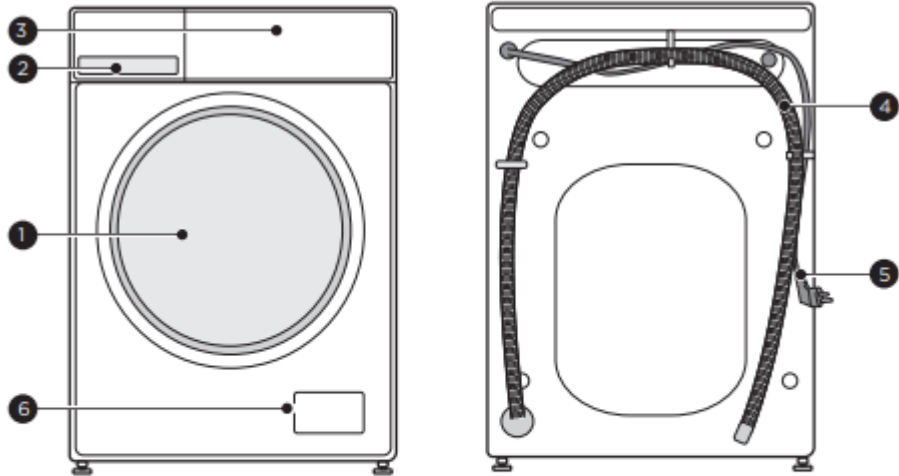

1	Door	4	Drain hose
2	Detergent dispenser	5	Power supply cord
3	Control panel	6	Service flap

Accessories

4 x Cover caps

1 x Supply hose cold water

1 x Owner's manual





## VI. USING THE APPLIANCE

### QUICK START GUIDE

- Before washing, please make sure the machine is installed properly.
- Your appliance was thoroughly checked before it left the factory. To remove any residual water and to neutralize potential odors, it's recommended to clean your appliance before first use. For this reason, start the Cotton program at 90°C without laundry and detergent

### Calibration

It's recommended to calibrate the machine, so that provide the best performance. The appliance is able to detect the amount of laundry loaded. This function is optimizing the product performance by minimizing energy and water consumption, saving you money and time. For this reason it's recommended to calibrate the appliance for best use.

- 1- Remove all accessories from the drum and close the door;
- 2- Insert the mains plug to the socket;
- 3- Switch on the washing machine and press "Temp." and "Delay" simultaneously for 10 seconds until "t19" is displayed;
- 4- Press [ ] to start the appliance and wait till "\*\*\*\*\*" is displayed .

### Before Washing

1. Plug in

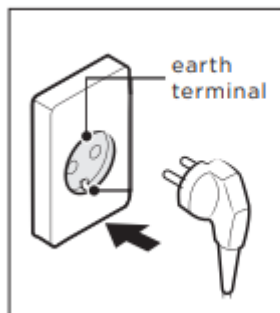

2. Open tap

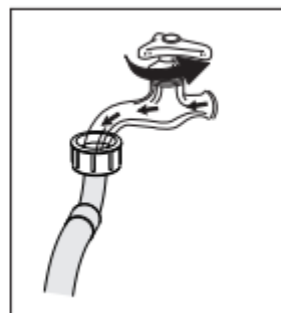

3. Load

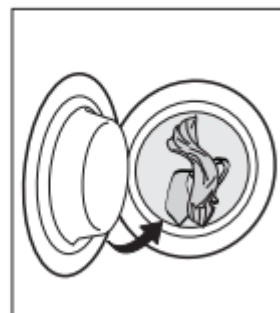

4. Close door

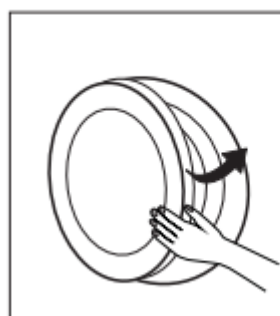

5. Add detergent

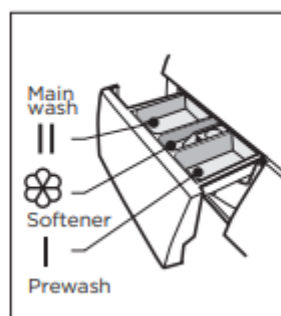

## Washing

1. Select programme

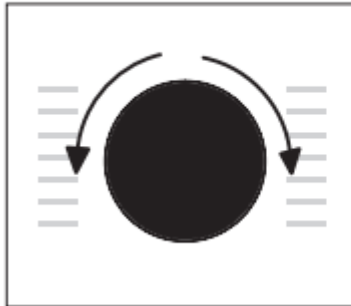

2. Select function or remain default settings

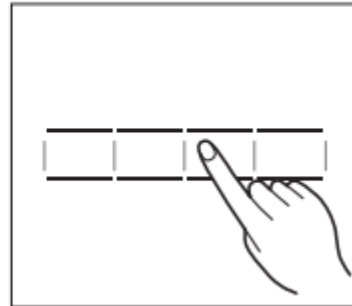

3. Press Start/Pause to start the program

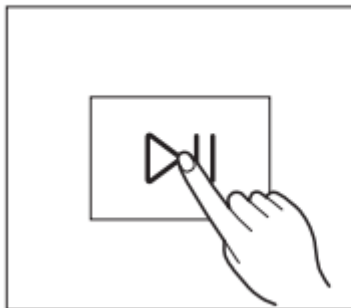

## After Washing

Buzzer beep and "End" on display

## VII. CONTROL PANEL

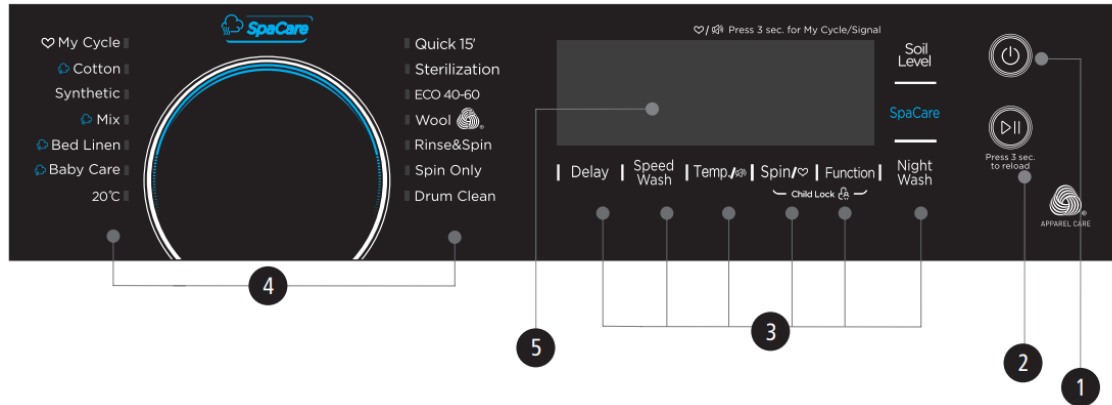

### 1 OFF

Turn the appliance on and off

### 2 Start/Pause

Start or pause your programme.

### 3 Option

This allows you to select additional functions and will light when selected.

### 4 Programs

Available according to the laundry type.

### 5 Display

The display shows settings, estimated remaining time, options and status messages.

### DISPLAY

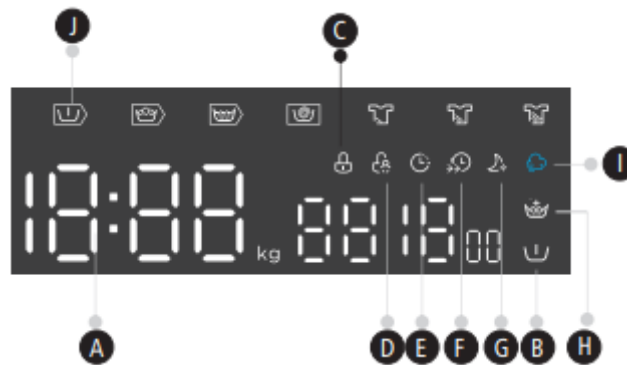

A – Display	F – Speed wash
B – Pre-wash	G – Night wash
C – Door lock	H – Extra rinse
D – Child lock	I – SpaCare
E – Delay	J – Pre wash-wash-rinse-spin

## VIII. OPERATING INSTRUCTIONS

### Before Each Washing

- The ambient temperature of the machine should be 5 -40°C. If used under 0°C, the inlet valve and draining system may be damaged. If the machine is installed under freezing conditions, it should be transferred to normal ambient temperature to ensure the water supply hose and drain hose can unfreeze before use.
- Please check your laundry care labels and the detergent use instructions before wash. Use non-foaming or less-foaming detergent suitable for machine properly.

1. Take all items out of the pockets



2. Sort laundry according to color and textile type

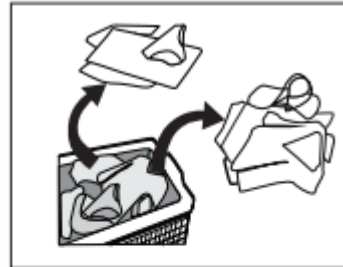

3. Tie together long textile strips and belts, close zips and button

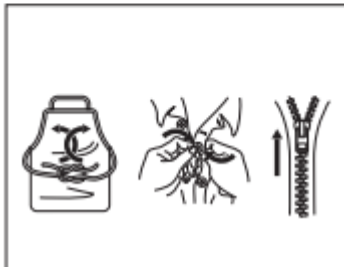

4. Put small items into a laundry bag



### WARNING

- Do not wash or dry articles that have been cleaned in, washed in, soaked in, or dabbed with combustible or explosive substances like wax, oil, paint, gasoline, alcohol, kerosene, and other flammable materials.
- Washing single clothes items may easily create big eccentricity. Therefore it is suggested to add one or two more laundry items to the wash so that spin can be done smoothly.
- Do not wash, spin water-proof seats, mats, or clothing.

**Detergent Dispenser**

- I Pre wash
- II Main wash
- ☼ Softener
- ☼ Release button to pull out the dispenser

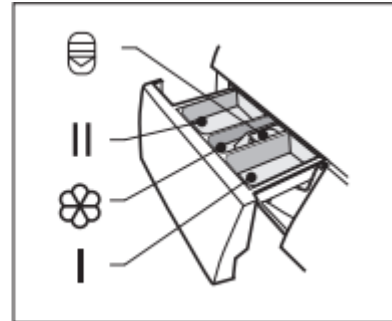

**CAUTION**

- Detergent only need to be added in compartment I "after selecting pre-wash function.

Programme	I	II / Δ	☼	Programme	I	II / Δ	☼
Cotton	○	●	○	Spin Only			
Synthetic	○	●	○	Rinse & Spin			○
Mix	○	●	○	Wool		●	○
Bed Linen	○	●	○	ECO 40-60		●	○
Baby Care	○	●	○	Sterilization		●	○
20°C		●	○	Quick 15'		●	○
Drum Clean							

**Detergent Recommendation**

Recommended washing detergent	Type of laundry and textile	Wash cycles	Washing temp
Heavy-duty detergent with bleaching agents and optical brighteners	White laundry made from boil-proof cotton or linen	Cotton, ECO Mix, BedLinen	20/30/40/60
Colour detergent without bleaching agent and optical brighteners	Coloured laundry made from cotton or linen	Cotton, Mix, BedLinen	Cold/20/30/40
Color or mild detergent without optical brighteners	Coloured laundry made from easy care fibres or synthetic materials	20C, Synthetic	20
Mild washing detergent	Delicate textiles, silk, viscose	Synthetic	20/30
Special wool detergent	Wool	Wool	20/30

- Please choose the suitable type of detergent to get a maximum of washing performance and a minimum of water and energy consumption.
- To achieve the best cleaning result a proper detergent dosing is important.
- Use a reduced detergent amount if the drum is not filled completely.
- Always adjust the amount of detergent to the water hardness, if your tap water is soft, use less detergent.
- Dose according to how dirty your laundry is, less dirty clothes require less detergent.
- Highly concentrated (compact detergent) requires particularly accurate dosing.

Following symptoms are a sign of detergent overdosing:

- heavy foam formation
- poor washing and rinsing result





Following symptoms are a sign of detergent under dosing:

- laundry turns grey
- built-up of limescale deposits on the drum, the heating element and/or the laundry







## IX. USING PROGRAMMES

## For HWM-M1014IVKB+++ model

<b>Cotton</b>	
Washing temperature	Cold, 20°C, 30°C, 40°C, 60°C, 90°C
Maximum dry laundry amount	10 kg
Spin speed selection( rpm)	0, 400, 600, 800, 1000, 1200, 1400
Additional functions	
Default program duration (Min)	03:39
Laundry type / descriptions	Hard-wearing textiles, heat-resistant textiles made of cotton or linen.
<b>Synthetic</b>	
Washing temperature	Cold, 20°C, 30°C, 40°C, 60°C
Maximum dry laundry amount	5 kg
Spin speed selection( rpm)	0, 400, 600, 800, 1000, 1200
Additional functions	
Default program duration (Min)	03:18
Laundry type / descriptions	Wash synthetic articles, for example: shirts, coats, blending. While washing the knitting textiles, detergent quantity shall be reduced due to its loose string construction and easily forming bubbles
<b>Baby Care</b>	
Washing temperature	Cold, 20°C, 30°C, 40°C, 60°C, 90°C
Maximum dry laundry amount	10 kg
Spin speed selection( rpm)	0, 400, 600, 800, 1000, 1200, 1400
Additional functions	
Default program duration (Min)	01:42
Laundry type / descriptions	Washing the baby's clothes, it can make the baby's wear cleaner. and make the rinse performance better to protect the baby skin.
<b>Bed Linen</b>	
Washing temperature	Cold, 20°C, 30°C, 40°C, 60°C
Maximum dry laundry amount	10 kg
Spin speed selection( rpm)	0, 400, 600, 800, 1000, 1200, 1400
Additional functions	
Default program duration (Min)	01:48
Laundry type / descriptions	This program is specially designed for washing duvet coats.



<b>Mix</b>	
Washing temperature	Cold, 20°C, 30°C, 40°C, 60°C, 90°C
Maximum dry laundry amount	10 kg
Spin speed selection( rpm)	0, 400, 600, 800, 1000, 1200, 1400
Additional functions	
Default program duration (Min)	01:20
Laundry type / descriptions	Mixed load consisting of textiles made of cotton and synthetics.
<b>20°C</b>	
Washing temperature	Cold, 20°C
Maximum dry laundry amount	5 kg
Spin speed selection( rpm)	0, 400, 600, 800, 1000, 1200
Additional functions	
Default program duration (Min)	01:01
Laundry type / descriptions	20°C default, can choose cold water
<b>Sterilization</b>	
Washing temperature	70°C
Maximum dry laundry amount	5 kg
Spin speed selection( rpm)	0, 400, 600, 800, 1000, 1200
Additional functions	
Default program duration (Min)	02:27
Laundry type / descriptions	Keep the washing temperature above 60 degrees for more than 30 minutes, effectively remove harmful bacteria
<b>Quick 15'</b>	
Washing temperature	Cold, 20°C, 30°C
Maximum dry laundry amount	2 kg
Spin speed selection( rpm)	0, 400, 600, 800
Additional functions	
Default program duration (Min)	00:15
Laundry type / descriptions	Extra short programme approx, suitable for lightly soiled washing as a small amounts of laundry
<b>Wool</b>	
Washing temperature	Cold, 20°C, 30°C, 40°C
Maximum dry laundry amount	2 kg
Spin speed selection( rpm)	0, 400, 600, 800
Additional functions	
Default program duration (Min)	01:07
Laundry type / descriptions	Hand or machine-washable wool or richwool textiles. Especially gentle wash programme to prevent shrinkage, longer programme pauses (textiles rest in wash liquor)



<b>Spin Only</b>	
Washing temperature	--
Maximum dry laundry amount	10 kg
Spin speed selection( rpm)	0, 400, 600, 800, 1000, 1200, 1400
Additional functions	 
Default program duration (Min)	00:12
Laundry type / descriptions	Extra spin with selectable spin speed.
<b>Rinse &amp; Spin</b>	
Washing temperature	--
Maximum dry laundry amount	10 kg
Spin speed selection( rpm)	0, 400, 600, 800, 1000, 1200, 1400
Additional functions	  
Default program duration (Min)	00:20
Laundry type / descriptions	Extra rinse with spin.
<b>ECO 40-60</b>	
Washing temperature	--
Maximum dry laundry amount	10 kg
Spin speed selection( rpm)	1400
Additional functions	
Default program duration (Min)	03:59
Laundry type / descriptions	Washing brightly colored clothes, it can protect the colors better. Default 40°C,not selectable,suitable for laundry washing at about 40°C-60°C
<b>Drum Clean</b>	
Washing temperature	90°C
Maximum dry laundry amount	0 kg
Spin speed selection( rpm)	--
Additional functions	 
Default program duration (Min)	01:18
Laundry type / descriptions	Specially set in this machine to clean the drum and tube. It applies 90 °C high temperature sterilization to make the clothes washing more green. When this programme is performed, the clothes or other washing cannot be added. When proper amount of chlorine bleaching agent is put in, the barrel cleaning effect will be better. The customer can use this programme regularly according to the need.

 - Delay  - Spa Care,  - Pre-Wash,  - Extra rinse,  -Night Wash,  -Speed Wash

**For HWM-M914IVKB+++ model**

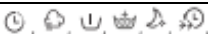
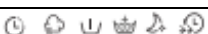
<b>Cotton</b>	
Washing temperature	Cold, 20°C, 30°C, 40°C, 60°C, 90°C
Maximum dry laundry amount	9 kg
Spin speed selection( rpm)	0, 400, 600, 800, 1000, 1200, 1400
Additional functions	
Default program duration (Min)	03:39
Laundry type / descriptions	Hard-wearing textiles, heat-resistant textiles made of cotton or linen.
<b>Synthetic</b>	
Washing temperature	Cold, 20°C, 30°C, 40°C, 60°C
Maximum dry laundry amount	4.5 kg
Spin speed selection( rpm)	0, 400, 600, 800, 1000, 1200
Additional functions	
Default program duration (Min)	03:18
Laundry type / descriptions	Wash synthetic articles, for example: shirts, coats, blending. While washing the knitting textiles, detergent quantity shall be reduced due to its loose string construction and easily forming bubbles
<b>Baby Care</b>	
Washing temperature	Cold, 20°C, 30°C, 40°C, 60°C, 90°C
Maximum dry laundry amount	9 kg
Spin speed selection( rpm)	0, 400, 600, 800, 1000, 1200, 1400
Additional functions	
Default program duration (Min)	01:42
Laundry type / descriptions	Washing the baby's clothes, it can make the baby's wear cleaner. and make the rinse performance better to protect the baby skin.
<b>Bed Linen</b>	
Washing temperature	Cold, 20°C, 30°C, 40°C, 60°C
Maximum dry laundry amount	9 kg
Spin speed selection( rpm)	0, 400, 600, 800, 1000, 1200, 1400
Additional functions	
Default program duration (Min)	01:48
Laundry type / descriptions	This program is specially designed for washing duvet coats.

<b>Mix</b>	
Washing temperature	Cold, 20°C, 30°C, 40°C, 60°C, 90°C
Maximum dry laundry amount	9 kg
Spin speed selection( rpm)	0, 400, 600, 800, 1000, 1200, 1400
Additional functions	
Default program duration (Min)	01:20
Laundry type / descriptions	Mixed load consisting of textiles made of cotton and synthetics.
<b>20°C</b>	
Washing temperature	Cold, 20°C
Maximum dry laundry amount	4.5 kg
Spin speed selection( rpm)	0, 400, 600, 800, 1000, 1200
Additional functions	
Default program duration (Min)	01:01
Laundry type / descriptions	20°C default, can choose cold water
<b>Sterilization</b>	
Washing temperature	70°C
Maximum dry laundry amount	4.5 kg
Spin speed selection( rpm)	0, 400, 600, 800, 1000, 1200
Additional functions	
Default program duration (Min)	02:27
Laundry type / descriptions	Keep the washing temperature above 60 degrees for more than 30 minutes, effectively remove harmful bacteria
<b>Quick 15'</b>	
Washing temperature	Cold, 20°C, 30°C
Maximum dry laundry amount	2 kg
Spin speed selection( rpm)	0, 400, 600, 800
Additional functions	
Default program duration (Min)	00:15
Laundry type / descriptions	Extra short programme approx, suitable for lightly soiled washing as a small amounts of laundry
<b>Wool</b>	
Washing temperature	Cold, 20°C, 30°C, 40°C
Maximum dry laundry amount	2 kg
Spin speed selection( rpm)	0, 400, 600, 800
Additional functions	
Default program duration (Min)	01:07
Laundry type / descriptions	Hand or machine-washable wool or richwool textiles. Especially gentle wash programme to prevent shrinkage, longer programme pauses (textiles rest in wash liquor)

<b>Spin Only</b>	
Washing temperature	--
Maximum dry laundry amount	9 kg
Spin speed selection( rpm)	0, 400, 600, 800, 1000, 1200, 1400
Additional functions	 
Default program duration (Min)	00:12
Laundry type / descriptions	Extra spin with selectable spin speed.
<b>Rinse &amp; Spin</b>	
Washing temperature	--
Maximum dry laundry amount	9 kg
Spin speed selection( rpm)	0, 400, 600, 800, 1000, 1200, 1400
Additional functions	  
Default program duration (Min)	00:20
Laundry type / descriptions	Extra rinse with spin.
<b>ECO 40-60</b>	
Washing temperature	--
Maximum dry laundry amount	9 kg
Spin speed selection( rpm)	1400
Additional functions	
Default program duration (Min)	03:48
Laundry type / descriptions	Washing brightly colored clothes, it can protect the colors better. Default 40°C,not selectable,suitable for laundry washing at about 40°C-60°C
<b>Drum Clean</b>	
Washing temperature	90°C
Maximum dry laundry amount	0 kg
Spin speed selection( rpm)	--
Additional functions	 
Default program duration (Min)	01:18
Laundry type / descriptions	Specially set in this machine to clean the drum and tube. It applies 90 °C high temperature sterilization to make the clothes washing more green. When this programme is performed, the clothes or other washing cannot be added. When proper amount of chlorine bleaching agent is put in, the barrel cleaning effect will be better. The customer can use this programme regularly according to the need.

 - Delay  - Spa Care,  - Pre-Wash,  - Extra rinse,  -Night Wash,  -Speed Wash

**For HWM-M914IVKB+++ model:**

Cycle	Nominal capacity in kg	Temperature setting	Cycle duration in h:m in	Energy consumption in kWh/cycle	Water consumption in L/cycle	Highest washing temperature °C <sup>1)</sup>	Residual moisture in % / Spin speed in rpm <sup>2)</sup>
20°C	4.5	20	1:01	0.189	48	20	65% / 1000
COTTON (60 °C)	9.0	60	3:44	1.734	78	60	53% / 1400
MIX	9.0	40	1:20	0.813	78	40	70% / 800
Quick 15'	2.0	Cold	0:15	0.030	31	Cold	70% / 800
Bed Linen	9.0	40	1:48	0.862	78	40	65% / 1000
ECO 40-60 <sup>3)</sup>	9.0	-	3:48	0.952	63.2	38	53% / 1350
	4.5	-	2:54	0.662	45.5	37	53% / 1350
	2.5	-	2:54	0.221	31.4	22	53% / 1350

**For HWM-M1014IVKB+++ model:**

Cycle	Nominal capacity in kg	Temperature setting	Cycle duration in h:m in	Energy consumption in kWh/cycle	Water consumption in L/cycle	Highest washing temperature °C <sup>1)</sup>	Residual moisture in % / Spin speed in rpm <sup>2)</sup>
20°C	5.0	20	1:01	0.195	51	20	65% / 1000
COTTON (60 °C)	10.0	60	3:44	1.972	85	60	53% / 1500
MIX	10.0	40	1:20	0.871	85	40	70% / 800
Quick 15'	2.0	Cold	0:15	0.030	31	Cold	75% / 800
Bed Linen	10.0	40	1:48	0.920	85	40	65% / 1000
ECO 40-60 <sup>3)</sup>	10.0	-	3:59	1.015	70.6	38	53% / 1450
	5.0	-	3:00	0.635	55.3	33	53% / 1450
	2.5	-	3:00	0.286	38.8	22	53% / 1450

- The above data is for reference only, and the data may change due to different actual use conditions.
- The valves given for programmes other than the ECO 40-60 programme are indicative only.
- Concerning to EN 60456:2016/prA2019 With (EU)2019/2014, (EU)2019/2023, The EU energy efficiency class is: B  
Energy test program: ECO 40-60.  
Other as the default.  
Half load for 10.0kg machine:5.0kg. Half load for 9.0kg machine:4.5kg.  
Quarter load for 10.0kg machine:2.5kg. Quarter load for 9.0kg machine:2.5kg.



### Spin Speed

When needed, the spinning speed can be adjusted pressing the Speed button in the following steps: 0-400-600-800-1000-1200-1400



### Delay

1. Select a programme
2. Press the Delay button to choose the delaying time 0-24h
3. Press [Start/Pause] to start the delay operation



Cancel the Delay function:

Press the [Delay] button before starting the programme. If the programme already started, should switch off programme to reset a new one.



### Pre Wash

Extra washing function before the main washing cycle starts to increase the washing performance.

Note: Detergent needs to be added to the compartment I.



**Extra Rinse** The laundry will undergo an extra rinse after selecting this function



### Temp.

When needed, the washing temperature can be adjusted by pressing the temperature button in the following steps: Cold - 20°C - 40°C - 60°C - 90°C.



### Soil Level

The washing time will increase or decrease after you select it.



### Speed

Wash The function can decrease the washing time



### My Cycle

After choosing the programme and setting the options, press [Spin] 3 sec. before start to wash. The default setting course is Cotton. To memory the frequently used programme.



### SpaCare

SpaCare function can be selected by choose "Cotton", "Mix" "Bed Linen" and "Baby Care". The customers can see the steam in the drum when operate SpaCare function



### Night Wash

If selected spinspeed is more than 800rpm , then change to 800rpm, meanwhile cancel the button sound.



### Child Lock

To avoid mis operation by children.



Press [Spin.] and [Function] simultaneously for 3 sec until the

buzzer beep. The child lock indicator switches on.

### CAUTION

When the Child Lock is activated, the display will alternately show "CL" and the remaining time.

Pressing any other button will cause the Child Lock indicator to flash for 3 sec. When the program ends, "CL" and "END" will alternate on the display.

The Child Lock deactivates the function of all buttons except the Child lock button! Only the simultaneous pressing of the two buttons [Temp.] and [Function] can deactivate the Child Lock! Please deactivate the Child Lock before selecting a new program!

**Mute the buzzer**

Choose the Programme



Press the [Temp.] button for 3sec.,  
the buzzer is mute.

To act the buzzer function, press the button again for 3 seconds. The setting will be kept until the next reset.

**CAUTION**

- After Muting the buzzer function, the sounds will not be activated any more

**Reload**

This operation can be executed during the washing progress. When the drum is still rolling and there is large amount of water with high temperature in the drum. The state is unsafe and the door cannot be opened forcefully. To Press [ ]3sec. to reload, and start the clothes adding in the midway function. Please follow the steps as bellow:

- 1.Wait until the drum stops rotation.
- 2.The door lock is unlocked.
- 3.Close the door when the clothes are reloaded and press the [Start/Pause] button.



## X. CLEANING AND MAINTENANCE

### CLEANING AND CARE

#### WARNING

- Always unplug the appliance and close the water tap before cleaning and maintenance.

#### Cleaning the Cabinet

Proper maintenance on the machine can extend its working life. The surface can be cleaned with diluted non abrasive neutral detergents when necessary. If there is any water overflow, use a towel to wipe it off immediately. Never use sharp items to clean the appliance.

#### CAUTION

- Never use abrasive or caustic agents. Such as formic acids or its diluted solvents or similar substances, like alcohol or chemical products.

#### Cleaning the Drum

Any rust stains left inside the drum by metal articles must be removed immediately using chlorine-free detergents. Never use steel wool for cleaning the drum!

#### Cleaning the Door Seal and Glass

Wipe the glass and seal after each wash to remove lint and stains. If lint builds up it can cause leakages. Remove any coins, buttons and other objects from the seal after each wash. Clean the door seal and glass every month to ensure the normal operation of the appliance

#### Cleaning the Inlet Filter

1. Close the tap and remove the water supply hose from it.

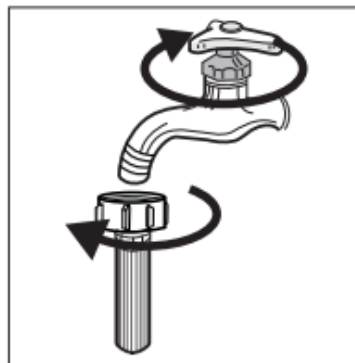

2. Clean the filter with a brush.

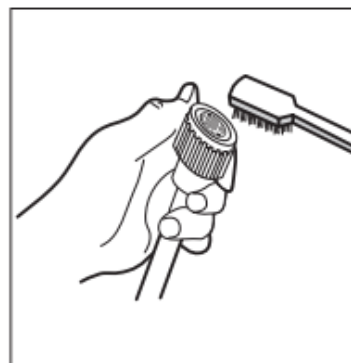

3. Unscrew the water supply hose from the backside of the machine.  
Pull out the filter with long nose pliers.

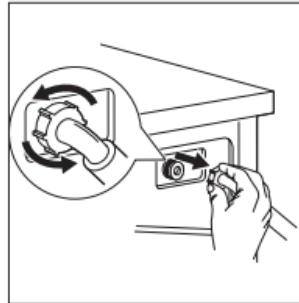

4. Use a brush to clean the filter.

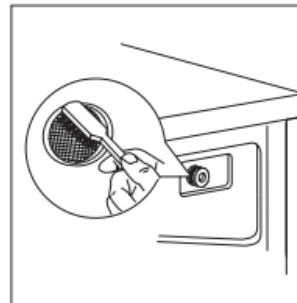

5. Reinstall the filter to the water inlet and reconnect the water supply hose.  
6. Clean the Inlet filter every 3 months to ensure the normal operation of the appliance.

### Cleaning the Detergent Dispenser

1. Press down the release [  ] on the softener cover and pull the dispenser drawer out of the recess. Clean the inside of the recess with a brush.
2. Lift the softener cover off the dispenser drawer and wash both items with water.
3. Restore the softener cover and push the drawer back into the recess.

1. Press the release and remove the dispenser drawer

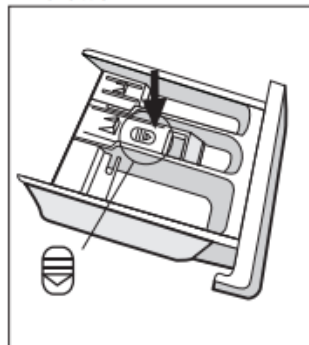

2. Clean the dispenser drawer and the softener cover under water

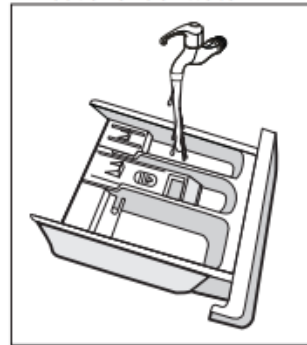

3. Clean the recess with a soft brush

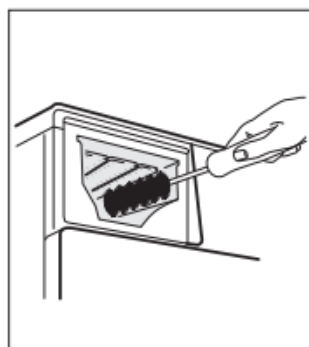

4. Insert the dispenser drawer

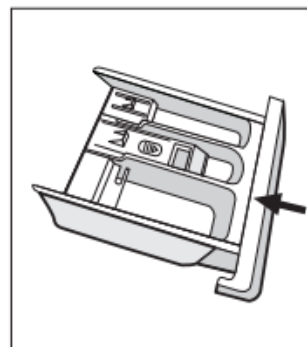

### Cleaning the Drain Pump Filter

#### WARNING

- Make sure that the machine has finished the washing cycle and is empty. Switch it off and unplug it before cleaning the drain pump filter.
- Be careful of hot water. Wait for water cooling down. Risk of scalding!
- Clean the filter periodically every 3 months to ensure the normal operation of the appliance.

1.Open the lower cover cap

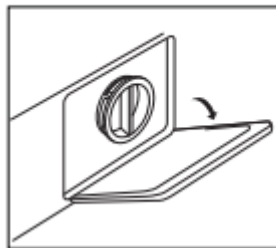

2.Open the filter by turning to the counter clockwise

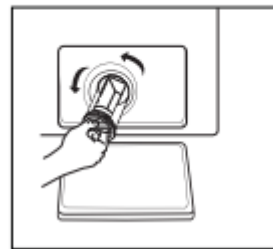

3.Remove extraneous matter



4.Close the lower cover cap

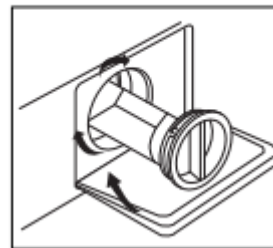

#### CAUTION

- When the appliance is in use and depending on the programme selected there can be hot water in the pump. Never remove the pump cover during a wash cycle, always wait until the appliance has finished the cycle, and is empty. When replacing the cover, ensure it is securely re-tightened.

## XI. TROUBLESHOOTING

Whenever there is a problem with the appliance, check if you can solve it following the tables below. If the problem persists, please contact the customer service.

Description	Possible Cause	Solution
Appliance does not start	Door is not closed properly. Clothes are stuck.	Close the door properly and restart. Check the laundry.
Door can't be opened	Safety protection is activated.	Disconnect the power and restart
Water leakage	Connections are not tight enough.	Check and fasten the water inlet pipe. Check and clean the outlet hose.
Detergent residues in the detergent dispenser	Detergent is damp and/or clotted.	Clean and wipe the detergent dispenser dry.
Indicator or display does not work	PC board or harness have connection problems.	Switch off the power and check if the mains plug is connected properly.
Abnormal noise	Fixing bolts are still in place. Floor is not solid or level.	Check if the fixing bolts have been removed. Make sure the appliance is installed on a solid and level floor.

### ERROR CODES

Description	Possible Cause	Solution
<b>E30</b>	Door is not closed properly.	Close the door properly and restart
<b>E10</b>	Water injecting problem during wash cycle.	Check if the water pressure is high enough. Straighten the water pipe. Clean the inlet valve filter.
<b>E21</b>	Overtime water draining	Check the drain hose for blockage.
<b>E12</b>	Water overflow	Restart the appliance
<b>EXX</b>	Others	Restart the appliance. If problem persists, please contact the customer service.



**Environment friendly disposal**

You can help protect the environment!

Please remember to respect the local regulations: hand in the non-working electrical equipment's to an appropriate waste disposal center.



**HEINNER** is a registered trademark of **Network One Distribution SRL**. Other brands and product names are trademarks or registered trademarks of their respective holders.

No part of the specifications may be reproduced in any form or by any means or used to make any derivative such as translation, transformation, or adaptation without permission from NETWORK ONE DISTRIBUTION.

Copyright © 2013 Network One Distribution. All rights reserved.

[www.heinner.com](http://www.heinner.com), <http://www.nod.ro>

<http://www.heinner.com>, <http://www.nod.ro>



This product is in conformity with norms and standards of European Community

Importer: **Network One Distribution**

Marcel Iancu Street, 3-5, Bucharest, Romania

Tel: +40 21 211 18 56, [www.heinner.com](http://www.heinner.com) , [www.nod.ro](http://www.nod.ro)

# HEINNER

## MASINA DE SPALAT AUTOMATA

Model:

HWM-M914IVKB+++/HWM-M1014IVKB+++



- Masina de spalat automata
- Capacitate: 9/10 kg
- Clasa energetica: B

Vă mulțumim pentru alegerea acestui produs!

## I. INTRODUCERE

***Înainte de a utiliza acest aparat, citiți cu atenție manualul de instrucțiuni și păstrați-l pentru consultări ulterioare.***

Acest manual este conceput pentru a vă oferi toate instrucțiunile necesare referitoare la instalarea, utilizarea și întreținerea aparatului.

Pentru utilizarea corectă și în siguranță a aparatului, vă rugăm să citiți cu atenție acest manual de instrucțiuni, înainte de instalare și utilizare.

## II. CONȚINUTUL PACHETULUI DUMNEAVOASTRĂ



- **Mașina de spălat rufe**
- **Manual de utilizare**
- **Certificat de garanție**

### III. MĂSURI DE SIGURANȚĂ

- Acest aparat este destinat utilizării în locuințe și alte unități similare, cum ar fi:
  - bucătăriile personalului din magazine, birouri și alte medii profesionale;
  - în gospodării și de către clienții din hoteluri, moteluri și alte medii de tip rezidențial;
  - în medii de tipul pensiune cu mic dejun;
  - în zone destinate utilizării în comun din blocuri de locuințe sau în spălătorii

#### PERICOL DE ELECTROCUTARE

- Când cablul de alimentare este deteriorat, acesta trebuie înlocuit de producător, de agentul service al acestuia sau de alte persoane cu calificări similare pentru a evita orice pericol.
- În cazul unei defecțiuni, mașina de spălat nu trebuie pusă în funcțiune înainte de a fi reparată de producător, de agentul service al acestuia sau de alte persoane cu calificări similare. Risc de electrocutare!
- Acest produs poate fi folosit de copii cu vârsta de cel puțin 8 ani și de persoane cu capacități fizice, senzoriale sau mentale reduse sau fără experiență și discernământ doar sub supraveghere sau dacă au primit instrucțiuni privind utilizarea acestuia în condiții de siguranță și dacă înțeleg pericolele implicate. Nu permiteți copiilor să se joace la mașina de spălat. Operațiunile de curățare și întreținere realizabile de către utilizator nu vor fi executate de copii nesupravegheați!
- Supravegheați copiii pentru a nu le permite să se joace la mașina de spălat.
- Copiii de 3 ani și mai mici nu vor fi lăsați în preajma mașinii de spălat sau vor fi permanent supravegheați.
- Există riscul ca animalele și copiii să intre în mașina de spălat. Verificați cuva înainte de fiecare utilizare!
- Nu vă urcați și nu vă așezați pe mașină!

#### LOCUL DE INSTALARE

- Țineți toate substanțele folosite la spălat și alte asemenea într-un loc sigur, ferit de accesul copiilor.
- Nu așezați mașina de spălat pe mochetă. Obstrucționarea orificiilor mașinii din cauza mochetei poate deteriora mașina.
- Instalați mașina de spălat la distanță de sursele de căldură și de lumina directă a soarelui pentru a evita deteriorarea componentelor din plastic și cauciuc.
- Nu folosiți mașina de spălat în spații cu umiditate mare sau în încăperi cu emisii de gaze explozive sau caustice. În caz de scurgeri sau stropi de apă, lăsați mașina să se usuce la aer liber.



- Nu instalați mașina de spălat în spatele unei uși cu sistem de blocare, a unei uși glisante sau a unei uși cu o balama pe partea opusă celei a ușii mașinii.
- Nu folosiți mașina în încăperi cu temperaturi sub 5°C pentru a nu deteriora componentele sale. Dacă acest lucru este totuși de neevitat, aveți grijă să drenați complet apa din mașină după fiecare utilizare.
- Nu folosiți niciodată pulverizatoare sau substanțe inflamabile în imediata apropiere a mașinii.

### **INSTALAREA**

- Înainte de utilizare, îndepărtați toate ambalajele și șuruburile de fixare folosite la transport. În caz contrar, mașina poate suferi daune severe.
- Această mașină este prevăzută cu o valvă de admisie simplă și se poate conecta doar la rețeaua de apă rece.
- Ștecherul mașinii trebuie să rămână accesibil după instalare.
- Înainte de prima spălare, realizați un ciclu complet de spălare în gol (fără rufe).
- Înainte de a folosi mașina de spălat, efectuați calibrările necesare.
- Nu puneți pe mașină obiecte excesiv de grele, ca de exemplu recipiente de apă sau dispozitive de încălzit.
- Folosiți seturile noi de furtunuri furnizate odată cu mașina. Nu reutilizați seturile vechi.
- Presiunea max. de admisie a apei este de 1 MPa. Presiunea min. de admisie a apei este de 0,05 MPa.

### **CONEXIUNEA ELECTRICĂ**

- Aveți grijă să nu prindeți cablul de alimentare sub mașină pentru a nu se deteriora.
- Conectați mașina la o priză cu siguranță și împământare, respectând valorile din tabelul de „Specificații tehnice”. Instalația cu împământare trebuie realizată de un electrician calificat. Asigurați-vă că instalarea mașinii se face în conformitate cu reglementările locale.
- Conexiunile la apă și cele electrice trebuie realizate de un tehnician calificat, cu respectarea instrucțiunilor producătorului și a reglementărilor locale privind siguranța.

### **Avertisment!**

- Nu folosiți ștechere multiple sau prelungitoare.
- Mașina nu trebuie să aibă un dispozitiv extern de comutare, ca de exemplu un cronometru, sau nu trebuie conectată la un circuit care este frecvent oprit și pornit.
- Nu trageți ștecherul din priză dacă sunt gaze inflamabile în jur.
- Nu scoateți niciodată ștecherul din priză cu mâinile ude.
- Apucați întotdeauna de ștecher, nu de cablu.
- Deconectați mașina de la curent ori de câte ori nu este folosită.

### **RACORDAREA LA APĂ**

- Verificați conexiunile conductelor de admisie a apei, robinetul de apă și furtunul de evacuare pentru a depista eventualele probleme cauzate de fluctuațiile de presiune a apei. Dacă aceste conexiuni sunt slăbite sau prezintă scurgeri, închideți robinetul de apă și reparați-l. Nu folosiți mașina înainte ca furtunurile și conductele să fie instalate de persoane calificate.
- Ușa mașinii de spălat se poate înfierbânta foarte tare în timpul funcționării. Nu lăsați copiii și animalele de companie în apropierea mașinii în timpul funcționării acesteia.
- Furtunurile de admisie și evacuare a apei trebuie instalate corect și păstrate intacte. În caz contrar, pot apărea scurgeri de apă.
- Nu scoateți filtrul pompei de evacuare cât timp în mașină este încă apă. În caz contrar, cantități mari de apă fierbinte se pot scurge în afară, cu risc de opărire.

### **MODUL DE FUNCȚIONARE ȘI ÎNTREȚINEREA**

- Nu folosiți niciodată niciun fel de solvenți inflamabili, explozivi sau toxici. Nu folosiți gaz și alcool ca detergenți. Alegeți doar detergenți recomandați pentru spălare automată.
- Aveți grijă să goliți toate buzunarele. Articolele ascuțite și dure, ca de exemplu monedele, broșele, cuiele, șuruburile, pietrele etc., pot cauza daune severe mașinii.
- Înainte de punerea mașinii în funcțiune, scoateți din buzunare toate obiectele, de ex. brichetele și chibriturile.
- Clătiți bine articolele care au fost spălate manual.
- Articolele pătate cu substanțe precum: ulei de gătit, acetonă, alcool, petrol, kerosen, soluții de scos pete, terebentină, ceară și soluții de îndepărtat ceara, trebuie spălate la temperatură ridicată cu o cantitate mai mare de detergent înainte de a fi uscate în mașină.
- Articolele care conțin cauciuc expandat (spumă de latex), căștile de duș, textilele impermeabile, articolele căptușite cu cauciuc și hainele sau pernele cu protecții din cauciuc expandat nu trebuie uscate în mașină.
- Balsamurile de rufe sau produsele similare trebuie folosite conform recomandărilor din instrucțiunile lor.
- Nu încercați niciodată să deschideți ușa mașinii cu forța. Ușa se va debloca automat la scurt timp după încheierea unui ciclu.
- Nu închideți ușa cu forță excesivă. Dacă ușa este greu de închis, verificați dacă ați introdus și distribuit corect rufele în cuvă.
- Deconectați întotdeauna mașina de la curent și închideți robinetul de apă înainte de a realiza operațiunile de curățare și întreținere și după fiecare folosire.
- Nu turnați niciodată apă peste mașină pentru a o curăța. Risc de electrocutare!

- Lucrările de reparații se vor efectua doar de producător, de agentul service al acestuia sau de persoane cu calificări similare pentru a evita orice pericol. Producătorul nu este responsabil pentru daunele survenite în urma intervenției unor persoane neautorizate

#### **TRANSPORTUL**

- Înainte de transport:
  - O persoană specializată va reinstala șuruburile de fixare a mașinii.
  - Apa acumulată va fi drenată din mașină.
- Mașina de spălat este grea. Transportul acesteia se va face cu grijă. Nu apucați niciodată de piesele proeminente ale mașinii când o ridicați. Ușa mașinii nu poate fi folosită ca mâner.

## IV. INSTALAREA

### Zona de instalare

- Stabilitatea este importantă pentru a preveni deplasarea produsului.
- Asigurați-vă că mașina este bine echilibrată și stabilă.
- Asigurați-vă că mașina nu este așezată pe cablul de alimentare.
- Asigurați-vă că păstrați distanțele minime față de pereți, conform imaginii.

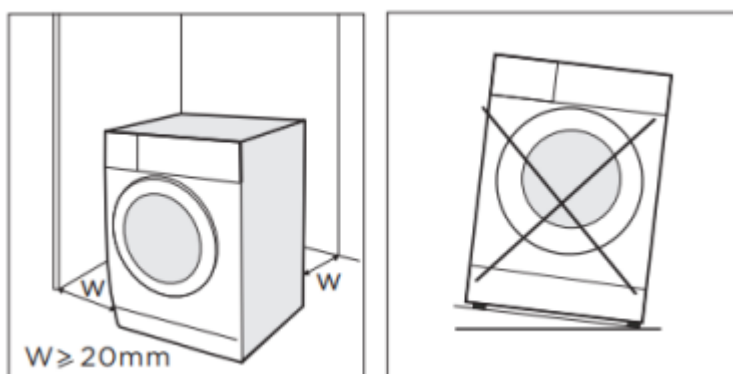

Înainte de a instala mașina, alegeți locul de instalare, urmărind ca acesta să prezinte următoarele caracteristici:

1. Suprafață tare, uscată și dreaptă.
2. Ferit de lumina directă a soarelui.
3. Ventilare suficientă.
4. Temperatura din încăpere, peste 0°C.
5. Departe de sursele de căldură, de ex. sobe pe cărbuni sau gaze.

### Echilibrarea mașinii de spălat

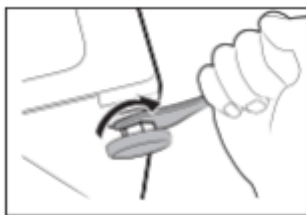

- Piulițele celor patru picioare trebuie bine strânse până la baza mașinii.

1. Slăbiți piulița.
2. Rotiți piciorul până când ajunge la nivelul solului.
3. Reglați picioarele și strângeți bine piulițele cu o cheie.
4. Asigurați-vă că mașina este dreaptă și stabilă.

### Scoaterea șuruburilor de fixare folosite la transport

- Înainte de a folosi mașina, scoateți șuruburile de fixare folosite la transport.
  1. Slăbiți cu o cheie cele 4 șuruburi de fixare folosite la transport.
  2. Scoateți șuruburile cu tot cu părțile din cauciuc și punețile la un loc sigur pentru a le putea folosi la nevoie.
  3. Astupați orificiile cu capacele prevăzute pentru aceasta.



### Conectarea furtunului de alimentare cu apă

Pentru a preveni daunele rezultate din scurgeri sau apă, respectați instrucțiunile.

- Nu îndoțiți, nu striviți și nu modificați furtunul de admisie a apei.
- Conectați furtunul de alimentare cu apă la valva de admisie a apei și un robinet de apă rece, ca în imagine.



### Furtunul de evacuare

- Nu îndoțiți și nu prelungiți furtunul de evacuare.
- Poziționați corect furtunul de evacuare pentru a evita daunele produse de eventualele scurgeri de apă.

Există două modalități de a amplasa capătul furtunului de evacuare:

1. Puneți-l în scurgerea de apă.

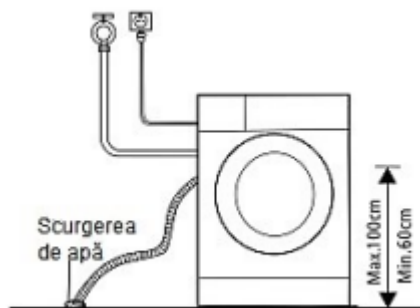

2. Conectați-l la conducta de evacuare a scurgerii.

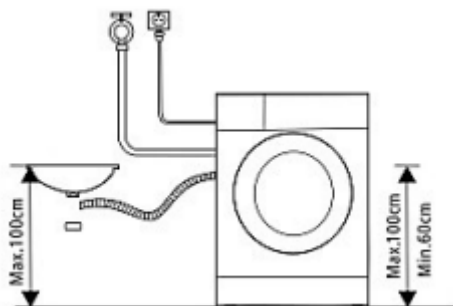

## V. DESCRIEREA PRODUSULUI

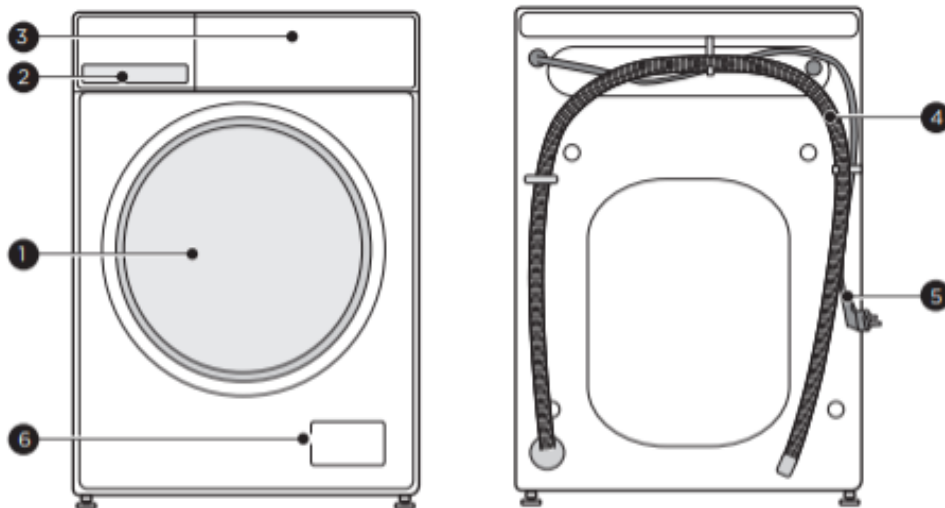

1. Usa	4. Furtun de evacuare
2. Sertar detergent	5. Cablu de alimentare
3. Panoul de control	6. Clapeta de serviciu

### Accesorii

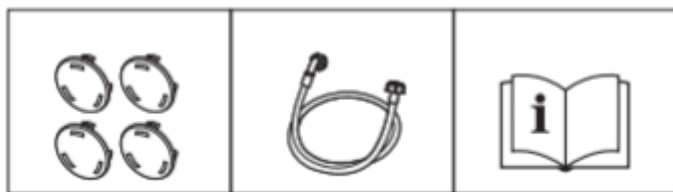

4 x capace de acoperire orificii  
 1 x furtun de alimentare apă rece  
 1 x Manual de utilizare

## VI. UTILIZAREA PRODUSULUI

- Înainte de a spăla, asigurați-vă că mașina este bine instalată.
- Produsul a fost verificat înainte de a ieși din fabrică. Pentru a îndepărta orice reziduuri de apă și a neutraliza eventualele mirosuri neplăcute, este recomandat să curățați mașina înainte de prima utilizare. Pentru aceasta, rulați programul Cotton (Bumbac) la 90°C, fără rufe și detergent.

### Calibrare

Este indicat să calibrați mașina pentru a obține randamentul maxim. Mașina poate detecta cantitatea de rufe încărcată în cuvă. Această funcție optimizează randamentul produsului, reducând consumul electric și de apă și, astfel, economisind bani și timp. Din acest motiv, este recomandat să calibrați mașina pentru o utilizare optimă.

1. Scoateți toate accesoriile din cuvă și închideți ușa.
2. Băgați ștecherul în priză.
3. Apăsăți butonul de pornire și apoi simultan „Temp.” și „Delay” timp de 10 secunde până când se afișează „t19”.
4. Apăsăți  pentru a pune mașina în funcțiune și așteptați până când se afișează „\*\*\*\*”.

### Înainte de spălare

1. Conectați.
2. Deschideți robinetul.
3. Încărcați.
4. Închideți ușa.
5. Adăugați detergent.

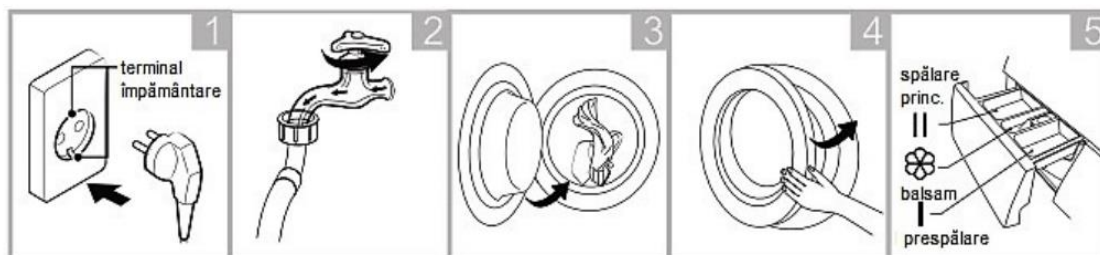



### Spălarea

1. Selectare program.
2. Selectare funcție sau păstrare setări prestabilite
3. Apăsați Start/Pauză pentru a porni programul.

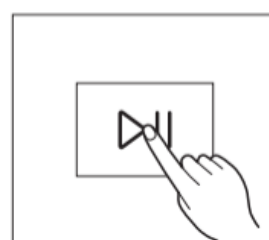
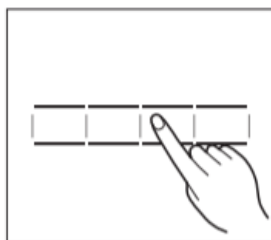
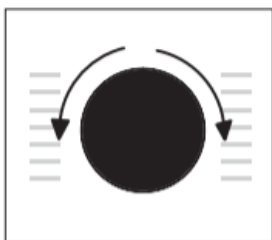

### După spălare

Se va auzi un semnal sonor și pe display va apărea mesajul „End”.

## VII. PANOUL DE CONTROL

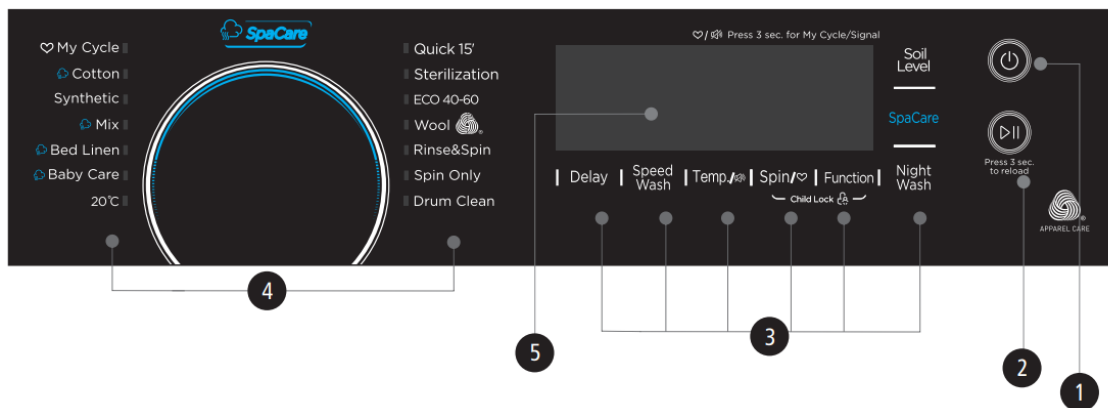
**1.OFF**

Mașina este on/off (pornită/oprită).

**2.Start/Pauza**

Apăsați acest buton pentru a porni sau întrerupe ciclul de spălare.

**3.Optiuni**

De aici puteți selecta o funcție suplimentară, iar la selectare ledul corespunzător se aprinde.

**4.Programe**

Disponibile în funcție de tipul de articole de spălat.

**5.Afisaj**

Afișajul arată setările, timpul estimat rămas, opțiunile și mesajele de spălare. Afișajul va rămâne activ pe toata durata ciclului de spălare.

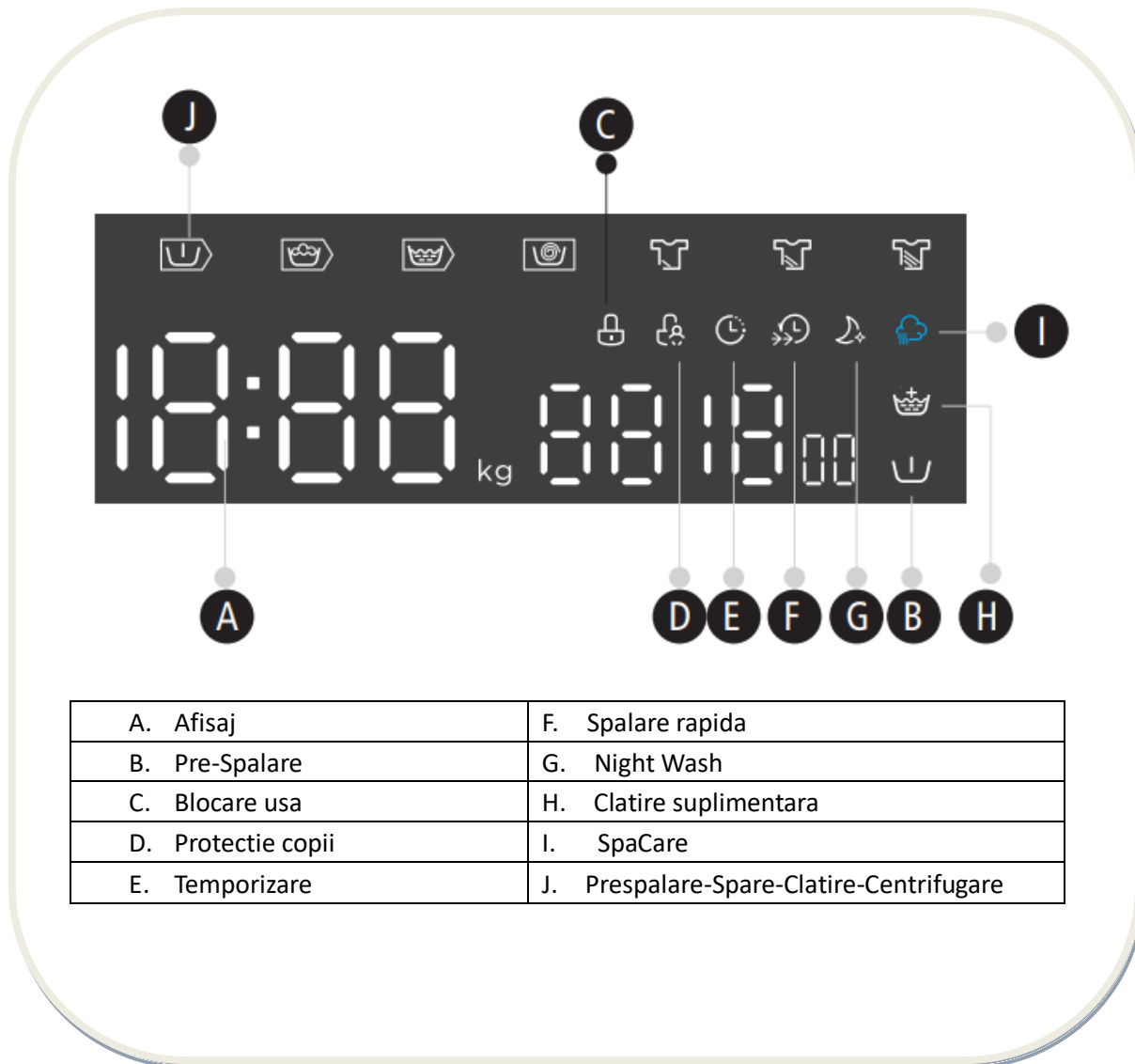

A. Afisaj	F. Spalare rapida
B. Pre-Spalare	G. Night Wash
C. Blocare usa	H. Clatire suplimentara
D. Protectie copii	I. SpaCare
E. Temporizare	J. Prespalare-Spare-Clatire-Centrifugare

## VIII. INSTRUCȚIUNI DE FOLOSIRE

### Înainte de fiecare spălare

- Temperatura din încăperea în care se află mașina de spălat trebuie să fie cuprinsă între 5-40°C. În cazul folosirii acesteia la temperaturi sub 0°C, valva de admisie și sistemul de evacuare pot avea de suferit. Dacă mașina este instalată în condiții de îngheț, aceasta trebuie mutată într-un loc cu o temperatură normală pentru ca furtunul de alimentare și furtunul de evacuare să se dezghețe înainte de folosire.
- Verificați etichetele articolelor de spălat și instrucțiunile de utilizare de pe detergent înainte de spălare. Folosiți detergent ne-spumant sau ușor spumant, adecvat pentru spălare automată.

Verificați eticheta de întreținere.

Scoateți toate obiectele din buzunare.

Sortați articolele după culoare și tipul țesăturii.

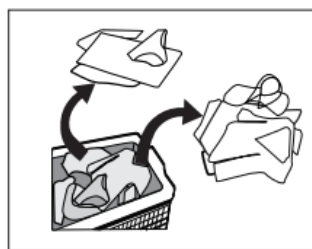
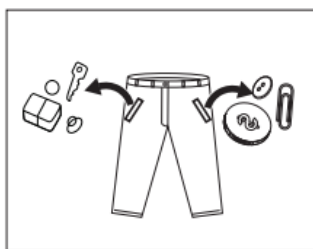

Legați șnururile și cordoanele lungi, închideți fermoarele și nasturii

Puneți articolele de mici dimensiuni într-un săculeț.

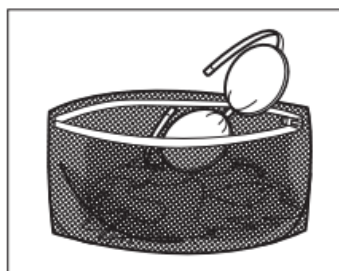
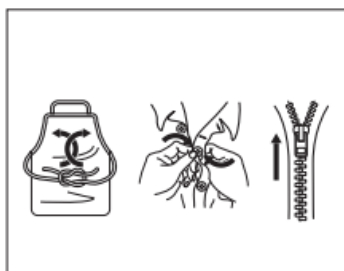



- Nu spălați în mașină articole care au fost în prealabil curățate, spălate, înmuiate sau îmbibate cu substanțe inflamabile sau explozive cum ar fi: ulei de parafină, vopsea, benzină, alcool, kerosen și alte substanțe inflamabile.
- Spălarea unui singur articol poate crea excentricitate și declanșa alarma din cauza dezechilibrului. Prin urmare, este recomandat să mai adăugați unul sau două articole de spălat pentru ca centrifugarea acestora să se facă lin.

### Compartimentul pentru detergent

I Prespălare



II Spălare principală

 Balsam

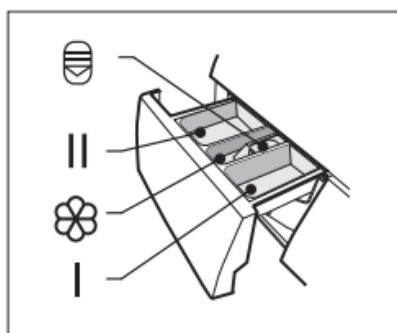
 Buton de eliberare pentru tragerea sertarului dozatorului



În compartimentul **I** se va adăuga detergent doar dacă ați selectat funcția de prespălare.

Program	<b>I</b>	<b>II / Δ</b>		Program	<b>I</b>	<b>II / Δ</b>	
Cotton	<input type="radio"/>	<input checked="" type="radio"/>	<input type="radio"/>	Spin Only			
Synthetic	<input type="radio"/>	<input checked="" type="radio"/>	<input type="radio"/>	Rinse&Spin			<input type="radio"/>
Mix	<input type="radio"/>	<input checked="" type="radio"/>	<input type="radio"/>	Wool		<input checked="" type="radio"/>	<input type="radio"/>
Bed Linen	<input type="radio"/>	<input checked="" type="radio"/>	<input type="radio"/>	ECO 40-60		<input checked="" type="radio"/>	<input type="radio"/>
Baby care	<input type="radio"/>	<input checked="" type="radio"/>	<input type="radio"/>	Sterilization		<input checked="" type="radio"/>	<input type="radio"/>
20 C	<input type="radio"/>	<input checked="" type="radio"/>	<input type="radio"/>	Quick 15'		<input checked="" type="radio"/>	<input type="radio"/>
Drum clean		<input checked="" type="radio"/>	<input type="radio"/>				

Obligatziu

Optional

## Recomandări privind detergentul

Detergent recomandat	Tip de articole și textile	Cicluri de spălare	Temp. de spălare
Detergent cu putere mare de curățare, cu agenți de înălbire și înălbitori optici.	Articole albe din bumbac și lenjerie de pat cu rezistență la fierbere	Cotton, ECO Mix, BedLinen	20/30/40/60
Detergent pentru rufe colorate, fără agenți de înălbire și înălbitori optici	Articole din bumbac și lenjeriile de pat colorate	Cotton, Mix, BedLinen	Rece/20/30/40
Detergent pentru rufe colorate, fără înălbitori optici.	Articole colorate din fibre ușor de întreținut și materiale sintetice.	20C, Synthetic	20
Detergent moderat de spălat	Textile delicate, mătase, viscoză.	Synthetic	20/30
Detergent special pentru articole din lână.	Lână	Wool	20/30

- Alegeți tipul adecvat de detergent pentru obține randamentul maxim de spălare și un consum minim de apă și energie.
- Pentru o curățare optimă, este important ca detergentul să fie corect dozat.
- Folosiți o cantitate redusă de detergent dacă nu ați încărcat complet cuva.
- Reglați întotdeauna cantitatea de detergent în funcție de duritatea apei; dacă apa de la robinet are o duritate mică, folosiți mai puțin detergent.
- Dozați în funcție de gradul de murdărie al articolelor de spălat; hainele mai puțin murdare necesită mai puțin detergent.
- Detergenții foarte concentrați (compacti) necesită o dozare extrem de precisă.

Următoarele simptome indică o supradozare a detergentului:

- spumare densă;
- spălare și clătire nereușite;





Următoarele simptome indică o subdozare a detergentului:

- articolele spălate devin gri;
- apar depuneri de calcar pe tambur, elementul de încălzire și/sau articolele de spălat.





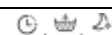



## IX. UTILIZAREA PROGRAMELOR

## Pentru modelul HWM-M1014IVKB+++

<b>Cotton</b>	
Temperatura de spalare	Rece, 20°C, 30°C, 40°C, 60°C, 90°C
Capacitatea maxima de rufe uscate	10 kg
Selectie viteza de rotatie (rpm)	0, 400, 600, 800, 1000, 1200, 1400
Functii suplimentare	
Durata implicita program (hh:min)	03:39
Tip de rufe/Descriere	Materiale textile rezistente la uzură, textile rezistente la căldură din bumbac sau in.
<b>Synthetic</b>	
Temperatura de spalare	Rece, 20°C, 30°C, 40°C, 60°C
Capacitatea maxima de rufe uscate	5 kg
Selectie viteza de rotatie (rpm)	0, 400, 600, 800, 1000, 1200
Functii suplimentare	
Durata implicita program (hh:min)	03:18
Tip de rufe/Descriere	Articole sintetice, cum ar fi: bluze, sacouri, amestecate. La spălarea tricotelor, cantitatea de detergent trebuie redusă deoarece, fiind confecționate cu ochiuri largi, acestea formează spumă ușor
<b>Baby Care</b>	
Temperatura de spalare	Rece, 20°C, 30°C, 40°C, 60°C, 90°C
Capacitatea maxima de rufe uscate	10 kg
Selectie viteza de rotatie (rpm)	0, 400, 600, 800, 1000, 1200, 1400
Functii suplimentare	
Durata implicita program (hh:min)	01:42
Tip de rufe/Descriere	Spălarea rufelor copiilor – hainele celor mici vor fi mai curate și mai bine clătite pentru protejarea pielii acestora
<b>Bed Linen</b>	
Temperatura de spalare	Rece, 20°C, 30°C, 40°C, 60°C
Capacitatea maxima de rufe uscate	10 kg
Selectie viteza de rotatie (rpm)	0, 400, 600, 800, 1000, 1200, 1400
Functii suplimentare	
Durata implicita program (hh:min)	01:48
Tip de rufe/Descriere	Acest program este special conceput pentru spălarea plapumelor.

<b>Mix</b>	
Temperatura de spalare	Rece, 20°C, 30°C, 40°C, 60°C, 90°C
Capacitatea maxima de rufe uscate	10 kg
Selectie viteza de rotatie (rpm)	0, 400, 600, 800, 1000, 1200, 1400
Functii suplimentare	
Durata implicita program (hh:min)	01:20
Tip de rufe/Descriere	Volum mixt de articole încărcate, constând din textile confecționate din bumbac și materiale sintetice
<b>20°C</b>	
Temperatura de spalare	Rece, 20°C
Capacitatea maxima de rufe uscate	5 kg
Selectie viteza de rotatie (rpm)	0, 400, 600, 800, 1000, 1200
Functii suplimentare	
Durata implicita program (hh:min)	01:01
Tip de rufe/Descriere	Program care foloseste apa rece, indicat pentru hainele colorate
<b>Sterilization</b>	
Temperatura de spalare	70°C
Capacitatea maxima de rufe uscate	5 kg
Selectie viteza de rotatie (rpm)	0, 400, 600, 800, 1000, 1200
Functii suplimentare	
Durata implicita program (hh:min)	02:27
Tip de rufe/Descriere	Acest program menține temperatura de spălare peste 60 de grade pentru mai mult de 30 de minute, eliminand eficient bacteriile dăunătoare.
<b>Quick 15'</b>	
Temperatura de spalare	Rece, 20°C, 30°C
Capacitatea maxima de rufe uscate	2 kg
Selectie viteza de rotatie (rpm)	0, 400, 600, 800
Functii suplimentare	
Durata implicita program (hh:min)	00:15
Tip de rufe/Descriere	Încărcături mixte de bumbac și materiale sintetice cu grad mic de murdărie
<b>Wool</b>	
Temperatura de spalare	Rece, 20°C, 30°C, 40°C
Capacitatea maxima de rufe uscate	2 kg
Selectie viteza de rotatie (rpm)	0, 400, 600, 800
Functii suplimentare	
Durata implicita program (hh:min)	01:07
Tip de rufe/Descriere	Textile din lână sau cu procent mare de lână care se spală manual sau la mașină. Program de spălare foarte delicată pentru ca articolele să nu intre la apă; pauze mai lungi în timpul derulării programului















<b>Spin Only</b>	
Temperatura de spalare	--
Capacitatea maxima de rufe uscate	10 kg
Selectie viteza de rotatie (rpm)	0, 400, 600, 800, 1000, 1200, 1400
Functii suplimentare	 
Durata implicita program (hh:min)	00:12
Tip de rufe/Descriere	Extra centrifugare cu viteză de centrifugare selectabilă.
<b>Rinse &amp; Spin</b>	
Temperatura de spalare	--
Capacitatea maxima de rufe uscate	10 kg
Selectie viteza de rotatie (rpm)	0, 400, 600, 800, 1000, 1200, 1400
Functii suplimentare	  
Durata implicita program (hh:min)	00:20
Tip de rufe/Descriere	Clătire suplimentara cu centrifugare
<b>ECO 40-60</b>	
Temperatura de spalare	--
Capacitatea maxima de rufe uscate	10 kg
Selectie viteza de rotatie (rpm)	1400
Functii suplimentare	
Durata implicita program (hh:min)	03:59
Tip de rufe/Descriere	Prestabilit la 40C, neselectabil, adecvat pentru spălare la aproximativ 40C-60C. Indicat pentru hainele colorate
<b>Drum Clean</b>	
Temperatura de spalare	90°C
Capacitatea maxima de rufe uscate	0 kg
Selectie viteza de rotatie (rpm)	--
Functii suplimentare	 
Durata implicita program (hh:min)	01:18
Tip de rufe/Descriere	Program special pentru a curăța tamburul și cuva. Acest program aplică sterilizare la temperatură ridicată de 90 °C. Când se folosește acest program, nu se introduc haine în cuva. Când se introduce cantitatea adecvată de agent de albire cu clor, efectul de curățare a cuvei va fi mai bun.

 - Delay  - Spa Care,  - Pre-Wash,  - Extra rinse,  - Night Wash,  - Speed Wash

**Pentru modelul HWM-M914IVKB+++**

<b>Cotton</b>	
Temperatura de spalare	Rece, 20°C, 30°C, 40°C, 60°C, 90°C
Capacitatea maxima de rufe uscate	9 kg
Selectie viteza de rotatie (rpm)	0, 400, 600, 800, 1000, 1200, 1400
Functii suplimentare	
Durata implicita program (hh:min)	03:39
Tip de rufe/Descriere	Materiale textile rezistente la uzură, textile rezistente la căldură din bumbac sau in.
<b>Synthetic</b>	
Temperatura de spalare	Rece, 20°C, 30°C, 40°C, 60°C
Capacitatea maxima de rufe uscate	4.5 kg
Selectie viteza de rotatie (rpm)	0, 400, 600, 800, 1000, 1200
Functii suplimentare	
Durata implicita program (hh:min)	03:18
Tip de rufe/Descriere	Articole sintetice, cum ar fi: bluze, sacouri, amestecate. La spălarea tricotajelor, cantitatea de detergent trebuie redusă deoarece, fiind confecționate cu ochiuri largi, acestea formează spumă ușor
<b>Baby Care</b>	
Temperatura de spalare	Rece, 20°C, 30°C, 40°C, 60°C, 90°C
Capacitatea maxima de rufe uscate	9 kg
Selectie viteza de rotatie (rpm)	0, 400, 600, 800, 1000, 1200, 1400
Functii suplimentare	
Durata implicita program (hh:min)	01:42
Tip de rufe/Descriere	Spălarea rufelor copiilor – hainele celor mici vor fi mai curate și mai bine clătite pentru protejarea pielii acestora
<b>Bed Linen</b>	
Temperatura de spalare	Rece, 20°C, 30°C, 40°C, 60°C
Capacitatea maxima de rufe uscate	9 kg
Selectie viteza de rotatie (rpm)	0, 400, 600, 800, 1000, 1200, 1400
Functii suplimentare	
Durata implicita program (hh:min)	01:48
Tip de rufe/Descriere	Acest program este special conceput pentru spălarea plapumelor.

<b>Mix</b>	
Temperatura de spalare	Rece, 20°C, 30°C, 40°C, 60°C, 90°C
Capacitatea maxima de rufe uscate	9 kg
Selectie viteza de rotatie (rpm)	0, 400, 600, 800, 1000, 1200, 1400
Functii suplimentare	
Durata implicita program (hh:min)	01:20
Tip de rufe/Descriere	Volum mixt de articole încărcate, constând din textile confecționate din bumbac și materiale sintetice
<b>20°C</b>	
Temperatura de spalare	Rece, 20°C
Capacitatea maxima de rufe uscate	4.5 kg
Selectie viteza de rotatie (rpm)	0, 400, 600, 800, 1000, 1200
Functii suplimentare	
Durata implicita program (hh:min)	01:01
Tip de rufe/Descriere	Program care foloseste apa rece, indicat pentru hainele colorate
<b>Sterilization</b>	
Temperatura de spalare	70°C
Capacitatea maxima de rufe uscate	4.5 kg
Selectie viteza de rotatie (rpm)	0, 400, 600, 800, 1000, 1200
Functii suplimentare	
Durata implicita program (hh:min)	02:27
Tip de rufe/Descriere	Acest program menține temperatura de spălare peste 60 de grade pentru mai mult de 30 de minute, eliminand eficient bacteriile dăunătoare.
<b>Quick 15'</b>	
Temperatura de spalare	Rece, 20°C, 30°C
Capacitatea maxima de rufe uscate	2 kg
Selectie viteza de rotatie (rpm)	0, 400, 600, 800
Functii suplimentare	
Durata implicita program (hh:min)	00:15
Tip de rufe/Descriere	Încărcături mixte de bumbac și materiale sintetice cu grad mic de murdărie
<b>Wool</b>	
Temperatura de spalare	Rece, 20°C, 30°C, 40°C
Capacitatea maxima de rufe uscate	2 kg
Selectie viteza de rotatie (rpm)	0, 400, 600, 800
Functii suplimentare	
Durata implicita program (hh:min)	01:07
Tip de rufe/Descriere	Textile din lână sau cu procent mare de lână care se spală manual sau la mașină. Program de spălare foarte delicată pentru ca articolele să nu intre la apă; pauze mai lungi în timpul derulării programului

<b>Spin Only</b>	
Temperatura de spalare	--
Capacitatea maxima de rufe uscate	9 kg
Selectie viteza de rotatie (rpm)	0, 400, 600, 800, 1000, 1200, 1400
Functii suplimentare	 
Durata implicita program (hh:min)	00:12
Tip de rufe/Descriere	Extra centrifugare cu viteză de centrifugare selectabilă.
<b>Rinse &amp; Spin</b>	
Temperatura de spalare	--
Capacitatea maxima de rufe uscate	9 kg
Selectie viteza de rotatie (rpm)	0, 400, 600, 800, 1000, 1200, 1400
Functii suplimentare	  
Durata implicita program (hh:min)	00:20
Tip de rufe/Descriere	Clatire suplimentara cu centrifugare
<b>ECO 40-60</b>	
Temperatura de spalare	--
Capacitatea maxima de rufe uscate	9 kg
Selectie viteza de rotatie (rpm)	1400
Functii suplimentare	
Durata implicita program (hh:min)	03:48
Tip de rufe/Descriere	Prestabilit la 40C, neselectabil, adecvat pentru spălare la aproximativ 40C-60C. Indicat pentru hainele colorate
<b>Drum Clean</b>	
Temperatura de spalare	90°C
Capacitatea maxima de rufe uscate	0 kg
Selectie viteza de rotatie (rpm)	--
Functii suplimentare	 
Durata implicita program (hh:min)	01:18
Tip de rufe/Descriere	Program special pentru a curăța tamburul și cuva. Acest program aplică sterilizare la temperatură ridicată de 90 °C. Când se folosește acest program, nu se introduc haine în cuva. Când se introduce cantitatea adecvată de agent de albire cu clor, efectul de curățare a cuvei va fi mai bun.

 - Delay  - Spa Care,  - Pre-Wash,  - Extra rinse,  -Night Wash,  -Speed Wash

## Pentru modelul HWM-M1014IVKB+++

Program	Capacitate nominala (Kg)	Temperatura (C)	Durata ciclului	Consumul electric în KWh/ciclu de operare	Consumul de apa in L/ciclu de operare	Temperatura maxima	Umiditate reziduală în %/ viteză de centrifugare
20C	5	20	1:01	0.195	51	20	65%/1000
Cotton 60C	10	60	3:44	1.972	85	60	53%/1500
Mix	10	40	1:20	0.871	85	40	70%/800
Quick 15	2	Rece	0.15	0.030	31	Rece	75%/800
Bed Linen	10	4	1:48	0.920	85	40	65%/1000
ECO 40-60	10	-	3:59	1.015	70.6	38	53%/1450
	5	-	3:00	0.635	55.3	33	53%/1450
	2.5	-	3:00	0.286	38.8	22	53%/1450

- Datele de mai sus sunt doar de referință și pot suferi modificări în funcție de condițiile efective de lucru.
- Valorile prezentate pentru alte programe decât ECO 40-60 au caracter pur orientativ
- În conformitatea cu Regulamentul EN 60456:2016/prA2019 ,(EU)2019/2014, (EU)2019/2023, Clasa de eficiență energetică UE este: B;  
Program de testare energetică: ECO 40-60  
Alte valori implicite  
Capacitatea de încărcare la jumătate pentru 9.0 kg: 4.5kg respectiv pentru 10.0kg: 5.0 kg  
Capacitatea de încărcare la sfert pentru 9.0kg: 2.5 kg, respectiv pentru 10.0kg: 2.5 kg

**Pentru modelul HWM-M914IVKB+++**

Program	Capacitate nominala (Kg)	Temperatura (C)	Durata ciclului	Consumul electric în KWh/ciclu de operare	Consumul de apa in L/ciclu de operare	Temperatura maxima	Umiditate reziduală în %/ viteză de centrifugare
20C	4.5	20	1:01	0.189	48	20	65%/1000
Cotton 60C	9	60	3:44	1.734	78	60	53%/1400
Mix	9	40	1:20	0.813	78	40	80%/800
Quick 15	2	Rece	0:15	0.030	31	Rece	70%/800
Bed Linen	9	40	1:48	0.862	78	40	65%/1000
ECO 40-60	9	-	3:48	0.952	63.2	38	53%/1350
	4.5	-	2:54	0.662	45.5	37	53%/1350
	2.5	-	2:54	0.221	31.4	22	53%/1350

**Viteză de centrifugare la stoarcere**

Apăsați acest buton pentru a schimba viteza de centrifugare. 0-400-600-800-1000-1200-1400

**Amânare pornire**

Activarea funcției de amânare a pornirii:

1. Selectați un program.
2. Apăsați butonul [Delay] pentru a selecta intervalul de amânare a pornirii (0-24 h.);
3. Apăsați butonul [Start/Pause] pentru a iniția procesul de amânare



Pentru a anula funcția de **amânare a pornirii**, apăsați butonul [Delay] înainte de lansarea programului până când pe afișaj apare valoarea 0 h. Dacă programul este deja pornit, opriți și reporniți mașina și selectați un program nou.

**Pre wash (Prespalare)**

Funcție de spălare suplimentară, preliminară lansării ciclului principal, pentru rezultate de curățare mai bune. Observație: Se va adăuga detergent în compartiment I

**Extra rinse (Clătire suplimentara)**

Prin selectarea acestei funcții, rufele vor fi clătite suplimentar.

**Temp.**

Apăsați acest buton pentru reglarea temperaturii (20°C, 30°C, 40°C, 60°C, 90°C).

**Soil level**

Timpul de spălare va crește sau scade după ce îl selectați.

**Rapid wash (Spalare rapida)**

Aceasta functie poate reduce timpul de spălare.

**Ciclul meu**

După alegerea programului și setarea opțiunilor, apăsați [Spin] 3 sec. înainte de Incepera programului. Setarea implicită este Bumbac.

Pentru a memora programul folosit frecvent.

**SpaCare**

Funcția SpaCare poate fi selectată alegând „Cotton”, „Mix”, „Bed Linen” și „Baby care”.

Se poate observa aburul din cuva atunci când acționează funcția SpaCare

**Night Wash**

Dacă viteza de centrifugare selectată este mai mare de 800 rpm, atunci aceasta scade automat la 800 rpm, automat dezactivandu-se și semnalele acustice.



### Blocare împotriva utilizării copiilor

Această funcție permite evitarea utilizării necorespunzătoare de către copii.



Apăsați cel două butoane timp de 3 secunde, pentru activarea acesteia.

Atenție! Apăsați cel două butoane timp de 3 secunde, atât pentru activarea funcției, cât și pentru dezactivarea acesteia. Funcția de „Protecție împotriva acționării de către copii” va bloca toate butoanele, cu excepția butonului [On/Off]. În cazul întreruperii alimentării cu energie electrică, funcția de protecție va fi dezactivată. În cazul anumitor modele, funcția va rămâne activă după restabilirea alimentării cu energie electrică



### Anularea semnalelor sonor



Apăsați butonul [Temp] timp de 3 secunde, pentru a trece pe modul silențios.

Pentru a activa funcția de semnale sonore, apăsați din nou butonul timp de 3 secunde.

Această setare se va păstra până la următoarea resetare



### Adăugare rufe

Aceasta se poate realiza în cursul procesului de spălare. Dacă tamburul încă se învâрте și există o cantitate mare de apă cu temperatură ridicată în cuvă, această condiție este nesigură și ușa nu se poate deschide forțat.

Apăsați butonul [Start/Pause] timp de 3 secunde pentru a reîncărca și adăugați articolele dorite în mijloc.

Urmați pașii de mai jos:

1. Așteptați până când tamburul nu se mai învâрте.
2. Sistemul de închidere a ușii se deblochează.
3. Închideți ușa după ce ați adăugat articolele dorite și apăsați butonul [Start/Pause].



## X. ÎNTREȚINERE ȘI MENTENANȚĂ

### Curățarea și întreținerea

- Scoateți ștecherul din priză și închideți robinetul de apă înainte de a realiza lucrările de curățare și întreținere.

### Curățarea exteriorului

O întreținere corectă a mașinii de spălat poate prelungi durata de viață a acesteia. Exteriorul acesteia se poate curăța cu detergenți neutri neabrazivi, diluați, la nevoie. Dacă observați scurgeri de apă pe suprafața mașinii, ștergeți imediat cu o cârpă. Nu folosiți niciodată obiecte ascuțite pentru a curăța mașina.

- Nu folosiți niciodată agenți abrazivi sau caustici, acizi formici sau solvenți diluați ai acestora, nici alte substanțe, precum: alcool sau agenți chimici

### Curățarea tamburului

Orice urme de rugină lăsate în interiorul tamburului de obiectele metalice trebuie îndepărtate imediat, folosind detergenți fără clor. Nu folosiți niciodată un burete metalic pentru a curăța tamburul

### Curățarea garniturii ușii și a geamului

Ștergeți geamul și garnitura după fiecare spălare pentru a îndepărta scamele și petele. Acumularea de scame poate determina scurgeri de apă. Îndepărtați orice monede, nasturi și alte obiecte rămase în garnitură după fiecare spălare. Curățați garnitura și geamul ușii o dată pe lună pentru a asigura funcționarea normală a mașinii.

### Curățarea filtrului interior

1. Închideți robinetul și scoateți furtunul de alimentare cu apă.
2. Curățați filtrul cu o perie.
3. Deșurubați furtunul de alimentare cu apă din spatele mașinii. Trageți filtrul cu un clește cu vârf lung.
4. Curățați filtrul cu o perie.

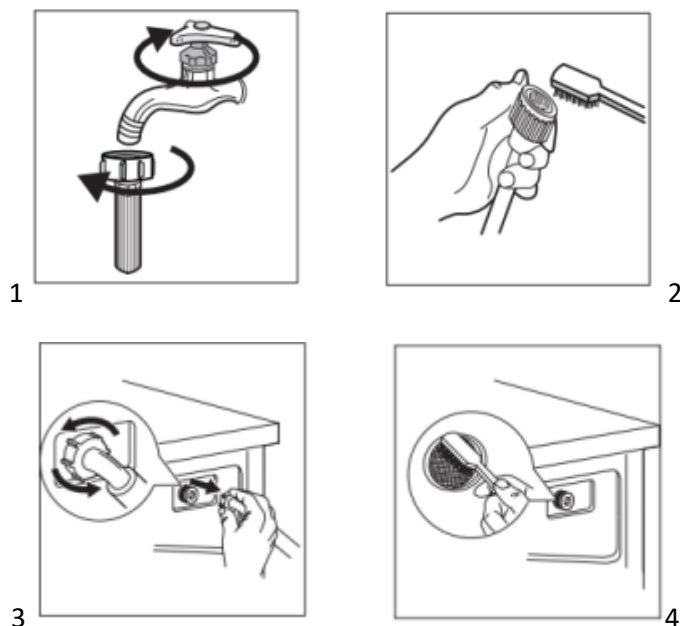

5. Remontați filtrul la loc pe admisia de apă și reconectați furtunul de alimentare cu apă.
6. Curățați filtru interior o dată la 3 luni pentru a asigura funcționarea normală a mașinii.

### Curățarea dozatorului de detergent

1. Apăsați butonul de eliberare [  ] de pe capacul compartimentului pentru balsam și trageți sertarul dozatorului afară. Curățați cu o perie spațiul destinat sertarului.
2. Ridicați capacul compartimentului pentru balsam din sertarul dozatorului și spălați ambele elemente cu apă.
3. Puneți la loc capacul compartimentului pentru balsam și împingeți sertarul la loc.

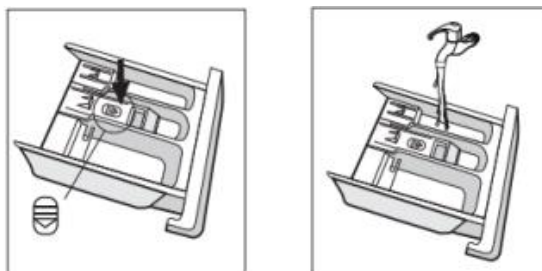

- Apăsați butonul de eliberare și scoateți sertarul dozatorului.  
Curățați sertarul dozatorului și capacul compartimentului pentru balsam sub jet de apă.

Curățați interiorul cu o perie moale.

Puneți la loc sertarul dozatorului.

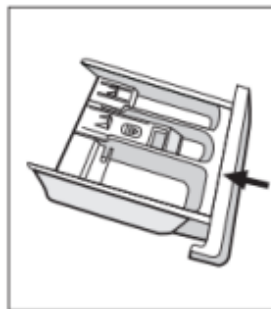
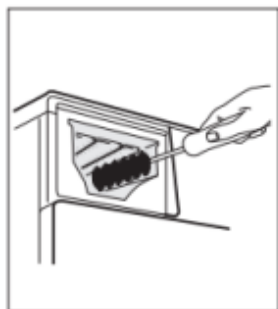

### Curățarea filtrului pompei de evacuare

1. Atenție la apa fierbinte!
2. Pentru evitarea riscului de electrocutare, scoateți mașina de spălat din priză înainte de curățarea filtrului.
3. Filtrul pompei de evacuare poate reține obiecte mici în timpul spălării.
4. Curățați periodic filtrul, pentru a asigura funcționarea normală a mașinii de spălat.

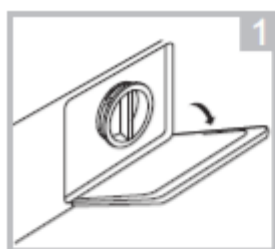

Deschideți capacul inferior

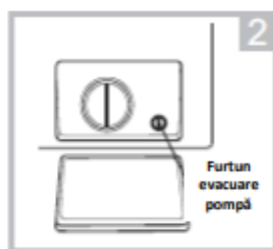

Rotiți la 90 de grade, scoateți furtunul, apoi scoateți dopul acestuia



După scurgerea apei, reintroduceți furtunul

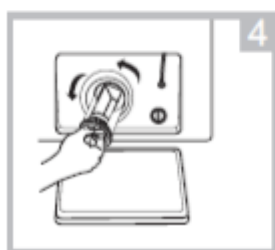

Desfaceți filtru prin rotire în sens contrar acelor de



Înlăturați obiectele străine

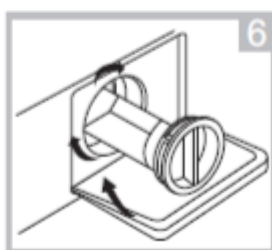

Închideți capacul inferior

În funcție de programul de spălare selectat, există posibilitatea ca în pompa de evacuare să fie apă fierbinte. Nu scoateți capacul pompei în timpul spălării, așteptați până la terminarea programului de spălare și golirea mașinii de spălat. Atunci când puneți capacul la loc, asigurați-vă că este strâns bine.

## XI. DEPANARE

În cazul în care mașina nu pornește sau se oprește în timpul funcționării, încercați mai întâi să depistați problema conform instrucțiunilor din tabelul de mai jos, apoi apelați la un centru de reparații.

Descriere	Cauză	Soluție
Mașina de spălat nu pornește	Ușa nu este închisă bine	Reporniți mașina de spălat după închiderea ușii. Asigurați-vă că rufele nu împiedică închiderea ușii
Ușa nu poate fi deschisă	Sistemul de siguranță al mașinii este în funcțiune.	Opriti și reporniți alimentarea cu energie
Scurgeri de apă	Racordurile furtunului de admisie sau evacuare nu sunt strânse suficient	Verificați și strângeți bine racordurile Curățați furtunul de evacuare
Sunt prezente reziduuri de detergent în sertar.	Detergentul este umed sau a format bulgări	Curățați și ștergeți sertarul pentru detergent
Indicatoarele luminoase sau afișajul nu funcționează	Probleme de alimentare	Asigurați-vă că alimentarea este pornită și că ștecărul este conectat corect
Zgomote neobișnuite	Șuruburile de fixare sunt încă la locul lor. Podeaua nu este solidă sau plană.	Asigurați-vă că șuruburile de fixare au fost îndepărtate Asigurați-vă că mașina este amplasată pe o podea solidă și plană

### CODURI DE EROARE

Descriere	Cauză	Soluție
E30	Ușa nu este închisă bine	Reporniți mașina de spălat după închiderea ușii Asigurați-vă că rufele nu împiedică închiderea ușii
E10	Probleme cu injectarea apei în timpul spălării	Asigurați-vă că presiunea de alimentare cu apă nu este prea scăzută Îndreptați furtunul de admisie. Verificați furtunul de admisie Asigurați-vă că filtrul de admisie nu este înfundat
E21	Evacuarea apei nu este corespunzătoare	Asigurați-vă că furtunul de evacuare nu este înfundat
E12	Preaplin apă	Reporniți mașina de spălat
EXX	Altele	Faceți toate verificările necesare, apoi apelați la un centru de reparații.



### **MASURI PENTRU PROTECTIA MEDIULUI**

Va informam ca persoanele fizice au urmatoarele obligatii prin legislatia specifica privind protectia mediului si regimul deseurilor:

- Deseurile de echipamente electrice si electronice (DEEE), pot contine substante periculoase pentru mediu si sanatatea umana. Conform OUG 5/2015, exista obligativitatea predarii acestora, pentru tratarea corespunzatoare si valorificarea componentelor reciclabile. Societatea Network One Distribution S.R.L. este platitoare de taxa de " timbru verde" pentru fiecare Echipament Electric si Electronic (EEE) pe care il pune pe piata. Acest cost asigura tratarea ulterioara a echipamentelor uzate colectate. Din acest motiv, odata ce devine deșeu, produsul EEE poate fi predat gratuit operatorului Dvs. de salubritate, la magazine atunci cand achizitionati alt echipament similar, sistemul "unul la unu "sau la punctul de colectare organizat de Primaria Sectorului / localitatii Dvs.
- Simbolul (marcajul) aplicat produselor, care indica faptul ca deseurile DEEE, bateriile si acumulatorii - fac obiectul unei colectari separate, il reprezinta o pubea barata cu o cruce.



#### ***Aceste masuri vor ajuta la protejarea mediului***

Societatea Network One Distribution S.R.L. este inregistrata in Registrul de punere pe piata a echipamentelor electrice si electronice, avand numarul de inregistrare: RO-2016-03-EEE-0201-IV. De asemenea, au fost intocmite si sunt gestionate: Registrul de Retragere EEE si Registrul de Rechemare EEE, in conformitate cu HG 322/2013. Totodata societatea este inregistrata in Registrul de punere pe piata a bateriilor, avnd numarul de inregistrare: RO-2011-03-B&A-0283. Conformitatea cu directiva RoHS: Produsul pe care l-ati cumpărat este conform cu Directiva RoHS UE (2011/65/UE). Nu conține materialele dăunătoare și interzise specificate în Directivă.

**Va multumim ca participati alaturi de noi la protejarea mediului si a sanatatii umane!**



**HEINNER** este o marcă înregistrată a companiei **Network One Distribution SRL**. Celelalte branduri și denumirile produselor sunt mărci de comerț sau mărci de comerț înregistrate ale respectivilor deținători.

Nicio parte a specificațiilor nu poate fi reprodusă sub nicio formă și prin niciun mijloc, nici utilizată pentru obținerea unor derivate precum traduceri, transformări sau adaptări, fără consimțământul prealabil al companiei NETWORK ONE DISTRIBUTION.

Copyright © 2013 Network One Distribution. Toate drepturile rezervate.

[www.heinner.com](http://www.heinner.com), <http://www.nod.ro>



Acest produs este proiectat și realizat în conformitate cu standardele și normele Comunității Europene.

Importator: **Network One Distribution**

Str. Marcel Iancu, nr. 3-5, București, România

Tel: +40 21 211 18 56, [www.heinner.com](http://www.heinner.com) , [www.nod.ro](http://www.nod.ro)

# HEINNER

## АВТОМАТИЧНА ПЕРАЛНА МАШИНА

Модел:

HWM-M914IVKB+++/HWM-M1014IVKB+++



- Перална машина
- Товароносимост: 9/10 kg
- Енергиен клас: B

Благодарим Ви за закупуването на този продукт!

## I. ВЪВЕДЕНИЕ

**Преди да използвате този уред прочетете внимателно наръчника с инструкции. Съхранявайте наръчника с цел бъдещи справки.**

Този наръчник е проектиран, за да Ви предостави всички необходими инструкции относно инсталирането, използването и поддържането на уреда.

Преди инсталиране и използване на уреда, с цел правилна и безопасна употреба на уреда, моля прочетете внимателно този наръчник с инструкции.

## II. СЪДЪРЖАНИЕ НА ВАШИЯ КОМПЛЕКТ



- Пералня със сушилня
- Наръчник за употреба
- Сертификат за гаранция



### III. ПРЕДПАЗНИ МЕРКИ

За Вашата безопасност следвайте инструкциите от този наръчник, за да намалите до минимум риска от пожар, взрив или токов удар както и за да предотвратите повреди на имуществото, тежки наранявания или смъртни случаи.

Значения на знаците:

**ПРЕДУПРЕЖДЕНИЕ!** Тази комбинация от знаци и думи за предупреждаване посочва потенциално опасна ситуация, която може да доведе до тежки наранявания или смърт, ако не е предотвратена.

**ВНИМАНИЕ!** Тази комбинация от знаци и думи за предупреждаване посочва потенциално опасна ситуация, която може да доведе до леки или незначителни наранявания или до повреждане на имуществото или околната среда.

**ЗАПОМНЕТЕ!** Тази комбинация от знаци и думи за предупреждаване посочва потенциално опасна ситуация, която може да доведе до леки или незначителни наранявания.

#### **ОПАСНОСТ ОТ ТОКОВ УДАР!**

- За предотвратяване на опасностите, ако захранващият кабел е повреден, трябва да се замени от производителя, от сервиза или от лица с подобна квалификация.
- Моля, използвайте новите маркучи, доставени заедно с пералната машина. Старите маркучи не трябва да се използват повторно.
- Преди извършване на всякакви операции за поддръжка, изключете уреда от източника за захранване с електроенергия.
- След всяка употреба на уреда изключвайте го от източника на захранване и спрете захранването с вода. Максималната стойност на налягането на подадената вода е посочена в паскали (Pa). Минималната стойност на налягането на подадената вода е посочена в паскали (Pa).
- За Вашата безопасност, щепселът на захранващия кабел трябва да се включва в триполюсен контакт, предвиден със заземяване. Проверете внимателно и се уверете, че контактът е заземен по съответстващ начин.
- Уверете се, че уреда е свързан към водопроводната мрежа и електрическата мрежа от квалифициран техник, в съответствие с инструкциите на производителя и местните разпоредби за безопасност.
- Изключете захранващия кабел, преди операциите за почистване или поддръжка.
- Не използвайте неподходящ контакт за захранване на пералната машина. Не изваждайте щепсела от контакта с мокри ръце.
- Не забравяйте да изключите пералнята от водопроводната мрежа и електрическата мрежа веднага след изпиране на дрехите.

#### **ОПАСНОСТ ЗА ДЕЦАТА!**

- Уредът може да се използва от деца на възраст най-малко 8 години и от лица с намалени физически, сетивни или умствени способности, или с липса на достатъчен опит и познания, само ако са под наблюдение или са получили указания във връзка с използването на уреда по безопасен начин и ако разбират опасностите, които могат да възникнат при използване на уреда. Децата нямат право да си играят с уреда. Почистването и поддръжката не трябва да се извършват от деца, които не са под наблюдение.

- Децата на възраст под 3 години трябва да се намират под наблюдение, така че да не си играят с уреда.
- Уверете се, че животни и деца не влизат в пералната машина. Проверявайте пералната машина преди всяка употреба.
- Децата трябва да бъдат под наблюдение, така че да не си играят с уреда.
- Стъклената врата може да стане много гореща по време на функциониране. Пазете децата и домашните любимци далеч от пералнята по време на функциониране в много влажни помещения или в стаи с взривни или корозивни газове.

#### **ОПАСНОСТ ОТ ВЗРИВ!**

- Не изпирайте и не изсушавайте изделия, които са почистени, изпрани или накснати във запалими или взривни вещества (восък, масло, боя, бензин, обезмаслител, разтворители за химическо чистене, керосин и др.), защото има опасност от възникване на пожар или взрив.
- Прането не трябва да се изсушава в уреда, ако са използвани промишлени химични вещества за тяхното почистване.
- Изведеният въздух не трябва да се освобождава в канал за дим с цел извеждане на изгорелите газове вследствие на употребата на други уреди.
- Преди тяхното поставяне в пералнята изплакнете ги добре ръчно.

#### **ВНИМАНИЕ!**

##### **ИНСТАЛИРАНЕ НА ПРОДУКТА:**

- Този уред е предназначен за използване само в закрити помещения.
- Тя не е предназначена за използване като вграден уред.
- Не покривайте отворите на пералната машина с текстилни материали или с други предмети.
- Пералните машини не могат да бъдат поставени в бани или стаи с голяма влажност, или в стаи с взривоопасни или разяждащи газове.
- Перилните машини с една входяща дюза за вода се свързват само към източника за студена вода. Перилните машини с двойна входяща дюза за вода се свързват към източника за студена и към източника за топла вода.
- Щепселът трябва да бъде достъпен след инсталиране на пералнята.
- Уредът не трябва да се инсталира зад блокируема врата, зад плъзгаща врата или зад врата с панта в противоположната страна на сушилнята за дрехи.
- Уредът не трябва да се инсталира в помещение с висока влажност.
- Този домакински електроуред не е предназначен за вграждане.
- Отстранете всички опаковки и болтовете за транспортиране преди употреба на пералнята. В противен случай могат да се появят сериозни повреди.

##### **РИСК ОТ ПОВРЕЖДАНЕ НА УРЕДА!**

- Продуктът е предназначен само за домашна употреба и за изпиране и изсушаване на текстилни изделия, които могат да се изпират и изсушават с този продукт.
- Не се качвайте и не сядайте върху капака на пералната машина.
- Не се подпирайте на вратата на пералната машина.

- Мерки за безопасност по време на маневриране на пералната машина:
  1. Транспортните болтове трябва да се монтират отново само от квалифициран техник.
  2. Акумулираната вода трябва да бъде изведена от пералнята.
  3. Боравяйте внимателно с пералнята. Когато вдигате пералнята, не я хващайте за издадените части. По време на преместване на пералнята, нейната врата не трябва да се използва като дръжка.
  4. Уредът е тежък. Транспортирайте го внимателно.
  5. Не поставяйте ръцете в барабана тогава, когато се върти.
- Моля не затваряйте вратата прилагайки прекалено голяма сила. Ако вратата се затваря трудно, проверете дали няма твърде много дрехи във ваната или дали са разпределени по съответстващ начин.
- Изпирането на килими е забранено

## IV. ИНСТАЛИРАНЕ

### Място на инсталацията

#### ПРЕДУПРЕЖДЕНИЕ!

- Стабилността на пералнята е много важна с цел предотвратяване на нейното предвижване по време на функциониране.
- Уверете се, че пералнята не е поставена върху захранващия кабел

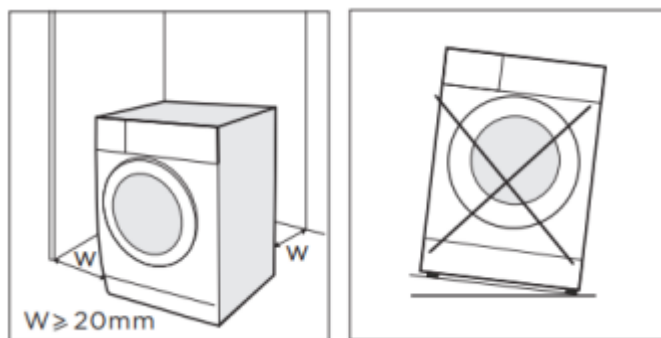

Преди да се инсталира пералнята, трябва да изберете място за инсталиране, което да има следните характеристики:

1. Твърдо, сухо и равно място.
2. Предотвратете поставянето на пряка слънчева светлина.
3. Уверете се, че мястото е достатъчно проветриво.
4. Стойността на температурата на стаята трябва да надвишава 5°C.
5. Не поставяйте пералнята в близост до източници на топлина, като тези въз основа на въглища или газ.

### Отстраняване на болтовете за транспортиране

#### ПРЕДУПРЕЖДЕНИЕ!

- Преди употреба на продукта е необходимо да извадите болтовете за транспортиране от неговата задна страна.
- Ще имате нужда от тези болтове, ако желаете да транспортирате продукта, така че съхранявайте ги на сигурно място.

Следвайте стъпките по-долу:

1. Разхлабете с ключ 4-те болта и извадете ги.
2. Покрийте отворите с предоставените капачки.
3. Съхранявайте болтовете за транспортиране, за да можете да ги използвате впоследствие

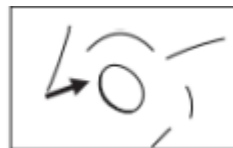

### НИВЕЛИРАНЕ НА ПЕРАЛНАТА МАШИНА

**ПРЕДУПРЕЖДЕНИЕ!** Гайките за фиксиране от четирите крачета трябва да се стягат добре за корпуса.

1. Уверете се, че крачетата са добре захванати за корпуса. В противен случай, поставете ги в първоначалната позиция и стегнете гайките.
2. Разхлабете гайките за фиксиране и завъртете крачетата, докато стигнат до пода.
3. Регулирайте крачетата и уверете се, пералнята е стабилна.

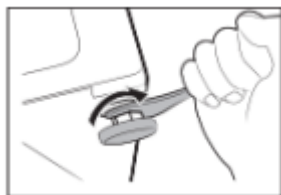

### СВЪРЗВАНЕ НА МАРКУЧА ЗА ЗАХРАНВАНЕ С ВОДА

**ПРЕДУПРЕЖДЕНИЕ!**

- С цел предотвратяване на изтичането на вода или повредите, причинени от нея, следвайте инструкциите от този раздел.
- Не огъвайте, не смачквайте, не променяйте и не разрязвайте маркуча за захранване с вода.
- За моделите, които имат входяща дюза за топла вода, свържете маркуча към дюзата и към крана за топла вода.

Консумацията на електроенергия ще спадне автоматично при някои програми за изпиране.

Свържете входящия маркуч съгласно указанията. Входящият маркуч може да се свърже по два начина:

Свързване на входящия маркуч към обикновен кран

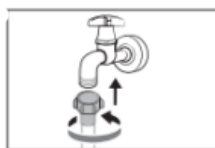

**МАРКУЧ ЗА ИЗВЕЖДАНЕ**  
**ПРЕДУПРЕЖДЕНИЕ!**

- Не огъвайте и не удължавайте маркуча за извеждане.
  - Позиционирайте по съответстващ начин маркуча за извеждане. В противен случай могат да се появят повреди поради течове на вода.
- Маркучът за извеждане може да се позиционира по два начина:

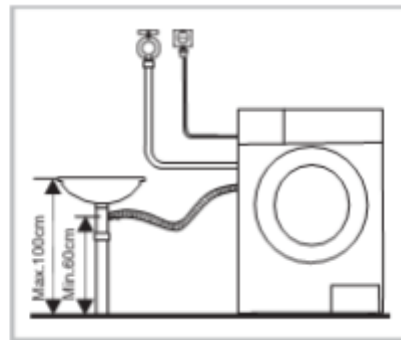
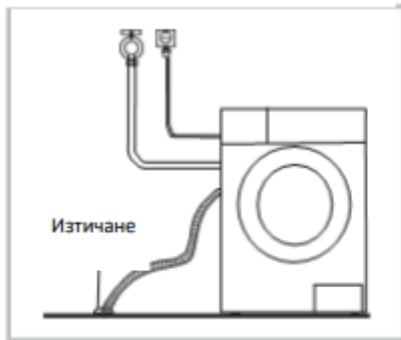

## V. ОПИСАНИЕ НА ПРОДУКТА

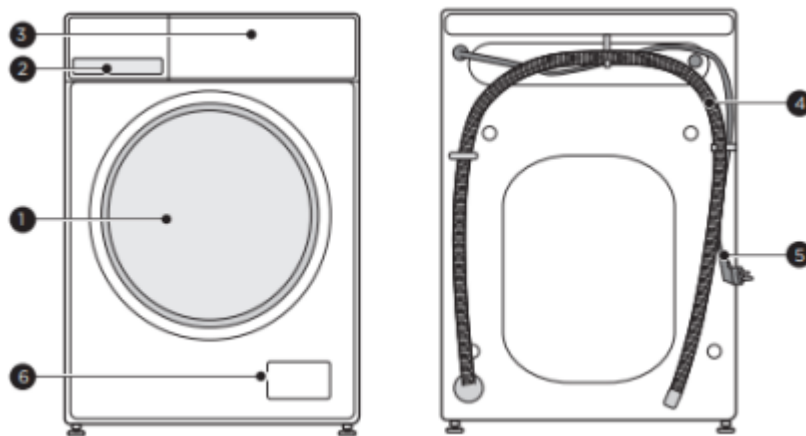

1. Врата	4. Маркуч за изпускане
2. Чекмедже за перилен препарат	5. Захранващ кабел
3. Контролен панел	6. Филтър

### АКСЕСОАРИ



- 4 x Капачки
- 1 x Маркуч за захранване със студена вода
- 1 x Наръчник за употреба

## VI. ИЗПОЛЗВАНЕ НА УРЕДА

### БЪРЗО ВКЛЮЧВАНЕ

#### ВНИМАНИЕ!

- Преди употреба на пералнята, уверете се, че е инсталирана по съответстващ начин.
- Преди първото изпиране на дрехи, пералнята трябва да извърши един пълен цикъл на изпиране, без пране, поставено вътре в нея.

#### Калибриране

Препоръчително е да калибрирате пералната машина, така че да ви служи по-добре.

1. Изпразнете пералнята;
2. Включете в контакта;
3. Включете пералната машина и натиснете Temp и Delay едновременно в рамките на 10 секунди, след което изведете „t19“.
4. Натиснете Старт / Пауза, за да стартирате пералнята и изчакайте, докато се покаже \*\*\*\*

#### ПРЕДИ ИЗПИРАНЕ

1. Включете щепсела в контакта
2. Отворете крана
3. Поставете дрехите за пране във ваната
4. Затворете вратата.
5. Поставете перилен препарат

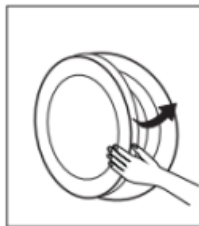
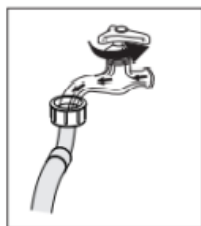
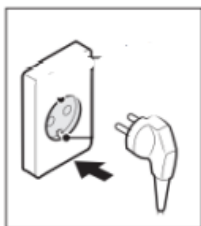

#### ИЗПИРАНЕ

1. Изберете програма
2. Изберете допълнителни функции
3. Включете програмата за изпиране



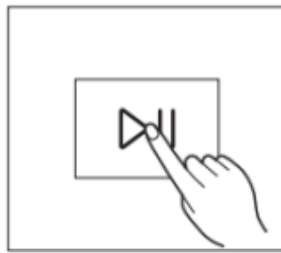
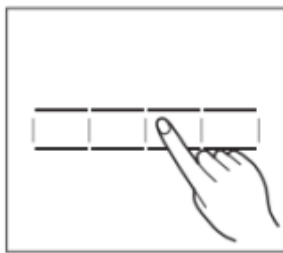
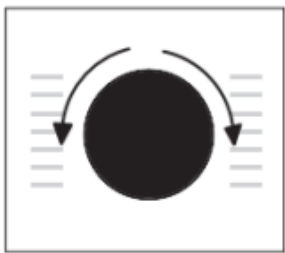

**СЛЕД ИЗПИРАНЕ**

Издава се звуков сигнал или се показва на екрана съобщение "End".

## VII. КОНТРОЛЕН ПАНЕЛ

S

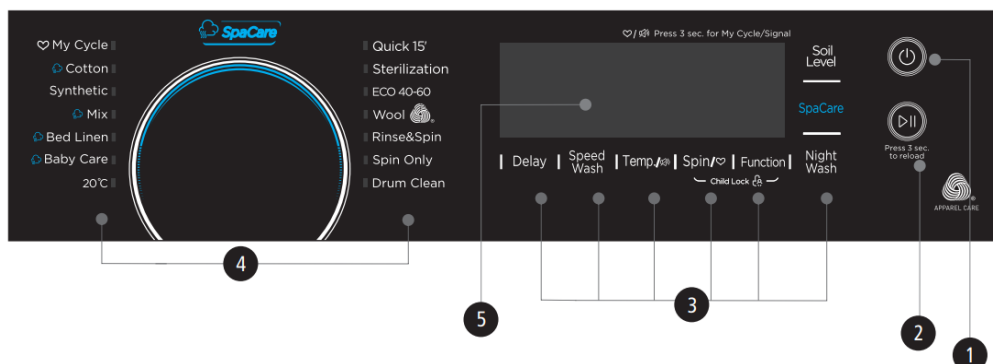
**1.ON/OFF** (Включване/Изключване)

Бутон за включване или изключване на уреда.

**2. START/PAUSE** (Старт/Пауза)

Натиснете този бутон с цел включване или прекъсване на програмата за изпиране.

**3. ОПЦИИ**

Тези бутони Ви позволяват избора на допълнителни функции.

**4. ПРОГРАМИ**

Съществуващи програми в зависимост от вида на дрехите.

**5. ЕКРАН**

Екранът показва настройките, прогнозираното време до края на програмата, опциите и съобщенията за състоянието на Вашата пералня. Екранът остава включен по време на действие на програмата за изпиране.

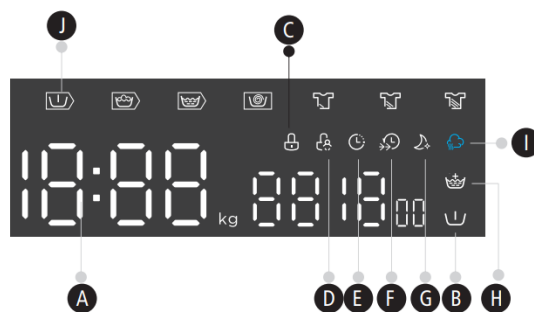

A. Дисплей	F. Скоростно пране
B. Предпране	G. Нощно измиване
C. Брава за врата	H. Допълнително изплакване
D. Заклучване за деца	I. SpaCare
E. Закъснение	J. Предпране-пране-изплакване-центрифуга

## VIII. ИНСТРУКЦИИ ЗА РАБОТА

## ПРЕДИ ВСЯКО ИЗПИРАНЕ

- Температурата за функциониране на пералната машина трябва да се намира в интервала (5-40)°C. Ако пералнята се съхранява в среда с температура 0°C или по-ниска, уредът трябва да се премести в среда с по-висока температура, за да се уверите, че маркучът за захранване с вода и този за извеждане не са замръзнали преди употреба.
- Преди да започнете изпирането, прочетете информацията върху етикетите и обясненията във връзка с начина на употреба на перилния препарат. Използвайте перилни препарати, които не образуват пяна или които образуват малко количество пяна и са подходящи за перална машина.



Прочетете  
информацията върху



Извадете предметите от  
джобовете

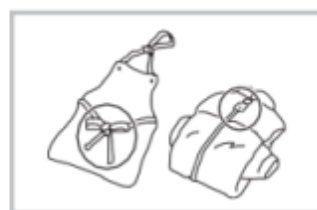

Връзвайте на възел дългите  
колани, закопчайте циповете и  
копчетата

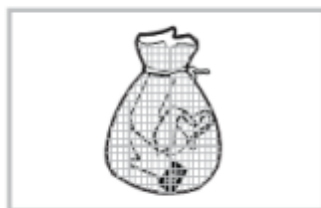

Поставете малките изделия в  
калъфка за възглавница или в  
специален сак

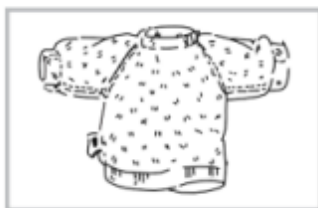

Обърнете наопаки изделията,  
които образуват лесно власинки и  
изделията с дълга нишка

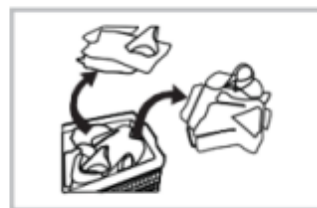





Отделете дрехите с  
различни видове тъкани

## ПРЕДУПРЕЖДЕНИЕ!

- При изпиране на една единствена дреха, ваната на пералната машина може да функционира по несъответстващ начин поради нарушаване на равновесието. Следователно Ви препоръчваме да добавите и други дрехи, така че извеждането на водата да се извършва по съответстващ начин.
- Не изпирайте дрехи, които са влезли в контакт с керосин, бензин, етилов алкохол или други запалими вещества

**ЧЕКМЕДЖЕ ЗА ПЕРИЛЕН ПРЕПАРАТ**

-  Перилен препарат за предпране
-  Перилен препарат за основно изпиране
-  Омекотител
-  Освободете бутона, за да издърпате дозатора

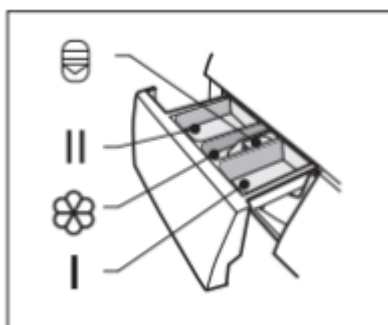
**ВНИМАНИЕ!**

Зареждането с перилен препарат на отделение "I" е необходимо само при избор на функцията за предпране за пералните, които имат тази функция

Програма				Програма			
Cotton	<input type="radio"/>	<input checked="" type="radio"/>	<input type="radio"/>	Spin Only			
Synthetic	<input type="radio"/>	<input checked="" type="radio"/>	<input type="radio"/>	Rinse&Spin			<input type="radio"/>
Mix	<input type="radio"/>	<input checked="" type="radio"/>	<input type="radio"/>	Wool		<input checked="" type="radio"/>	<input type="radio"/>
Bed Linen	<input type="radio"/>	<input checked="" type="radio"/>	<input type="radio"/>	ECO 40-60		<input checked="" type="radio"/>	<input type="radio"/>
Baby care	<input type="radio"/>	<input checked="" type="radio"/>	<input type="radio"/>	Sterilization		<input checked="" type="radio"/>	<input type="radio"/>
20 C	<input type="radio"/>	<input checked="" type="radio"/>	<input type="radio"/>	Quick 15'		<input checked="" type="radio"/>	<input type="radio"/>
Drum clean		<input checked="" type="radio"/>	<input type="radio"/>				

Означава задължително

Означава опционално

- Моля, изберете подходящия тип перилен препарат, за да получите максимална производителност на пране и а минимална консумация на вода и енергия.
- За постигане на най-добър резултат от почистване е важно правилното дозиране на препарата.
- Използвайте намалено количество препарат, ако барабанът не е пълен напълно.
- Винаги съобразявайте количеството на препарата с твърдостта на водата, ако чешмяната ви вода е мека, използвайте по-малко препарат.
- Дозирайте според това колко мръсно е прането ви, по-малко мръсните дрехи изискват по-малко перилен препарат.
- Силно концентриран (компактен препарат) изисква особено точно дозиране.

Следните симптоми са признак за предозиране на перилен препарат:

- образуване на силна пяна
- лош резултат от пране и изплакване

Следните симптоми са признак за недостатъчно дозиране на препарата:









- прането става сиво
- натрупване на варовик върху барабана, нагревателния елемент и/или прането

## IX. ИЗПОЛЗВАНЕ НА ПРОГРАМИ

## За HWM-M1014IVKB+++

<b>Cotton</b>	
Температура на изпиране	Студ, 20°C, 30°C, 40°C, 60°C, 90°C
Максимално количество сухо пране	10 kg
Избор на скорост на въртене (rpm)	0, 400, 600, 800, 1000, 1200, 1400
Допълнителни функции	
Продълж. на програмата по подразбиране	03:39
Вид на прането/описание	Дрехи устойчиви на износване и топлина, изработени от памук или лен.
<b>Synthetic</b>	
Температура на изпиране	Студ, 20°C, 30°C, 40°C, 60°C
Максимално количество сухо пране	5 kg
Избор на скорост на въртене (rpm)	0, 400, 600, 800, 1000, 1200
Допълнителни функции	
Продълж. на програмата по подразбиране	03:18
Вид на прането/описание	Препоръчана с цел изпиране на синтетични изделия: блузи, якета, изделия от смес на синтетични фибри и др. Тогава, когато перете трикотажни изделия, количеството на перилния препарат трябва да се намали с цел предотвратяване образуването на прекалено голямо количество пяна.
<b>Baby Care</b>	
Температура на изпиране	Студ, 20°C, 30°C, 40°C, 60°C, 90°C
Максимално количество сухо пране	10 kg
Избор на скорост на въртене (rpm)	0, 400, 600, 800, 1000, 1200, 1400
Допълнителни функции	
Продълж. на програмата по подразбиране	01:42
Вид на прането/описание	Изпирането на дрехите на бебето може да направи дрехите на бебето по-чисти и да направи изплакването по-добро, за да защити бебешката кожа.
<b>Bed Linen</b>	
Температура на изпиране	Студ, 20°C, 30°C, 40°C, 60°C
Максимално количество сухо пране	10 kg
Избор на скорост на въртене (rpm)	0, 400, 600, 800, 1000, 1200, 1400
Допълнителни функции	
Продълж. на програмата по подразбиране	01:48
Вид на прането/описание	Тази програма е специално предназначена за пране на пухени палта





<b>Mix</b>	
Температура на изпиране	Студ, 20°C, 30°C, 40°C, 60°C, 90°C
Максимално количество сухо пране	10 kg
Избор на скорост на въртене (rpm)	0, 400, 600, 800, 1000, 1200, 1400
Допълнителни функции	
Продълж. на програмата по подразбиране	01:20
Вид на прането/описание	Смесено зареждане на памучни и синтетични дрехи
<b>20°C</b>	
Температура на изпиране	Студ, 20°C
Максимално количество сухо пране	5 kg
Избор на скорост на въртене (rpm)	0, 400, 600, 800, 1000, 1200
Допълнителни функции	
Продълж. на програмата по подразбиране	01:01
Вид на прането/описание	Прането на ярко оцветени дрехи може да защити цветовете по-добре
<b>Sterilization</b>	
Температура на изпиране	70°C
Максимално количество сухо пране	5 kg
Избор на скорост на въртене (rpm)	0, 400, 600, 800, 1000, 1200
Допълнителни функции	
Продълж. на програмата по подразбиране	02:27
Вид на прането/описание	Поддържайте температурата на пране над 60 градуса за повече от 30 минути, ефективно премахване на вредните бактерии.
<b>Quick 15'</b>	
Температура на изпиране	Студ, 20°C, 30°C
Максимално количество сухо пране	2 kg
Избор на скорост на въртене (rpm)	0, 400, 600, 800
Допълнителни функции	
Продълж. на програмата по подразбиране	00:15
Вид на прането/описание	Тази програма е подходяща за бързо изпиране на малък брой дрехи, които са леко замърсени
<b>Wool</b>	
Температура на изпиране	Студ, 20°C, 30°C, 40°C
Максимално количество сухо пране	2 kg
Избор на скорост на въртене (rpm)	0, 400, 600, 800
Допълнителни функции	
Продълж. на програмата по подразбиране	01:07
Вид на прането/описание	Текстил от вълна или богата вълна, която може да се мие ръчно или в машина. Особено нежна програма за пране, за да се предотврати свиването, по-дълги паузи на програмата (текстилт почива в течност за пране).

<b>Spin Only</b>	
Температура на изпиране	--
Максимално количество сухо пране	10 kg
Избор на скорост на въртене (rpm)	0, 400, 600, 800, 1000, 1200, 1400
Допълнителни функции	 
Продълж. на програмата по подразбиране	00:12
Вид на прането/описание	Допълнително центрофугиране с възможност за избор на скоростта за центрофугиране
<b>Rinse &amp; Spin</b>	
Температура на изпиране	--
Максимално количество сухо пране	10 kg
Избор на скорост на въртене (rpm)	0, 400, 600, 800, 1000, 1200, 1400
Допълнителни функции	  
Продълж. на програмата по подразбиране	00:20
Вид на прането/описание	Допълнително изплакване с центрофугиране.
<b>ECO 40-60</b>	
Температура на изпиране	--
Максимално количество сухо пране	10 kg
Избор на скорост на въртене (rpm)	1400
Допълнителни функции	
Продълж. на програмата по подразбиране	03:59
Вид на прането/описание	Прането на ярко оцветени дрехи може да защити цветовете по-добре. По подразбиране 40°C, не може да се избира, подходящо за пране при около 40°C-60°C
<b>Drum Clean</b>	
Температура на изпиране	90°C
Максимално количество сухо пране	0 kg
Избор на скорост на въртене (rpm)	--
Допълнителни функции	 
Продълж. на програмата по подразбиране	01:18
Вид на прането/описание	Специално поставен в тази машина за почистване на барабана и тръбата. Прилага се 90 °C високотемпературна стерилизация, за да направи дрехите пране повече зелено. Когато се изпълнява тази програма, дрехите или др пране не може да се добави. Когато правилното количество хлорно избелване се постави агент, ефектът от почистване на цвята ще бъде по-добър. Клиентът може да използва тази програма редовно според нуждите..









 - Delay  - Spa Care,  - Pre-Wash,  - Extra rinse,  -Night Wash,  -Speed Wash



## За HWM-M914IVKB+++

<b>Cotton</b>	
Температура на изпиране	Студ, 20°C, 30°C, 40°C, 60°C, 90°C
Максимално количество сухо пране	9 kg
Избор на скорост на въртене (rpm)	0, 400, 600, 800, 1000, 1200, 1400
Допълнителни функции	
Продълж. на програмата по подразбиране	03:39
Вид на прането/описание	Дрехи устойчиви на износване и топлина, изработени от памук или лен.
<b>Synthetic</b>	
Температура на изпиране	Студ, 20°C, 30°C, 40°C, 60°C
Максимално количество сухо пране	4.5 kg
Избор на скорост на въртене (rpm)	0, 400, 600, 800, 1000, 1200
Допълнителни функции	
Продълж. на програмата по подразбиране	03:18
Вид на прането/описание	Препоръчана с цел изпиране на синтетични изделия: блузи, якета, изделия от смес на синтетични фибри и др. Тогава, когато перете трикотажни изделия, количеството на перилния препарат трябва да се намали с цел предотвратяване образуването на прекалено голямо количество пяна.
<b>Baby Care</b>	
Температура на изпиране	Студ, 20°C, 30°C, 40°C, 60°C, 90°C
Максимално количество сухо пране	9 kg
Избор на скорост на въртене (rpm)	0, 400, 600, 800, 1000, 1200, 1400
Допълнителни функции	
Продълж. на програмата по подразбиране	01:42
Вид на прането/описание	Изпирането на дрехите на бебето може да направи дрехите на бебето по-чисти и да направи изплакването по-добро, за да защити бебешката кожа.
<b>Bed Linen</b>	
Температура на изпиране	Студ, 20°C, 30°C, 40°C, 60°C
Максимално количество сухо пране	9 kg
Избор на скорост на въртене (rpm)	0, 400, 600, 800, 1000, 1200, 1400
Допълнителни функции	
Продълж. на програмата по подразбиране	01:48
Вид на прането/описание	Тази програма е специално предназначена за пране на пухени палта

<b>Mix</b>	
Температура на изпиране	Студ, 20°C, 30°C, 40°C, 60°C, 90°C
Максимално количество сухо пране	9 kg
Избор на скорост на въртене (rpm)	0, 400, 600, 800, 1000, 1200, 1400
Допълнителни функции	
Продълж. на програмата по подразбиране	01:20
Вид на прането/описание	Смесено зареждане на памучни и синтетични дрехи
<b>20°C</b>	
Температура на изпиране	Студ, 20°C
Максимално количество сухо пране	4.5 kg
Избор на скорост на въртене (rpm)	0, 400, 600, 800, 1000, 1200
Допълнителни функции	
Продълж. на програмата по подразбиране	01:01
Вид на прането/описание	Прането на ярко оцветени дрехи може да защити цветовете по-добре
<b>Sterilization</b>	
Температура на изпиране	70°C
Максимално количество сухо пране	4.5 kg
Избор на скорост на въртене (rpm)	0, 400, 600, 800, 1000, 1200
Допълнителни функции	
Продълж. на програмата по подразбиране	02:27
Вид на прането/описание	Поддържайте температурата на пране над 60 градуса за повече от 30 минути, ефективно премахване на вредните бактерии.
<b>Quick 15'</b>	
Температура на изпиране	Студ, 20°C, 30°C
Максимално количество сухо пране	2 kg
Избор на скорост на въртене (rpm)	0, 400, 600, 800
Допълнителни функции	
Продълж. на програмата по подразбиране	00:15
Вид на прането/описание	Тази програма е подходяща за бързо изпиране на малък брой дрехи, които са леко замърсени
<b>Wool</b>	
Температура на изпиране	Студ, 20°C, 30°C, 40°C
Максимално количество сухо пране	2 kg
Избор на скорост на въртене (rpm)	0, 400, 600, 800
Допълнителни функции	
Продълж. на програмата по подразбиране	01:07
Вид на прането/описание	Текстил от вълна или богата вълна, която може да се мие ръчно или в машина. Особено нежна програма за пране, за да се предотврати свиването, по-дълги паузи на програмата (текстилт почива в течност за пране).

<b>Spin Only</b>	
Температура на изпиране	--
Максимално количество сухо пране	9 kg
Избор на скорост на въртене (rpm)	0, 400, 600, 800, 1000, 1200, 1400
Допълнителни функции	 
Продълж. на програмата по подразбиране	00:12
Вид на прането/описание	Допълнително центрофугиране с възможност за избор на скоростта за центрофугиране
<b>Rinse &amp; Spin</b>	
Температура на изпиране	--
Максимално количество сухо пране	9 kg
Избор на скорост на въртене (rpm)	0, 400, 600, 800, 1000, 1200, 1400
Допълнителни функции	  
Продълж. на програмата по подразбиране	00:20
Вид на прането/описание	Допълнително изплакване с центрофугиране.
<b>ECO 40-60</b>	
Температура на изпиране	--
Максимално количество сухо пране	9 kg
Избор на скорост на въртене (rpm)	1400
Допълнителни функции	
Продълж. на програмата по подразбиране	03:48
Вид на прането/описание	Прането на ярко оцветени дрехи може да защити цветовете по-добре. По подразбиране 40°C, не може да се избира, подходящо за пране при около 40°C-60°C
<b>Drum Clean</b>	
Температура на изпиране	90°C
Максимално количество сухо пране	0 kg
Избор на скорост на въртене (rpm)	--
Допълнителни функции	 
Продълж. на програмата по подразбиране	01:18
Вид на прането/описание	Специално поставен в тази машина за почистване на барабана и тръбата. Прилага се 90 °C високотемпературна стерилизация, за да направи дрехите пране повече зелено. Когато се изпълнява тази програма, дрехите или др пране не може да се добави. Когато правилното количество хлорно избелване се постави агент, ефектът от почистване на цевта ще бъде по-добър. Клиентът може да използва тази програма редовно според нуждите..

 - Delay  - Spa Care,  - Pre-Wash,  - Extra rinse,  -Night Wash,  -Speed Wash

## За модел HWM-M914IVKB+++

Цикъл	Номинален капацитет в кг	Настройка на температурата °C	Продължителност на цикъла в часове и минути	Консумация на енергия в kWh/работен цикъл	Консумация на вода в литри/работен цикъл	най-висока температура (C)	Остатъчна влага в % /скорост на центрофуга в об./мин
20C	4.5	20	1:01	0.189	48	20	65%/1000
Cotton 60C	9	60	3:44	1.734	78	60	53%/1400
Mix	9	40	1:20	0.813	78	40	80%/800
Quick 15	2	студ	0:15	0.030	31	студ	70%/800
Bed Linen	9	40	1:48	0.862	78	40	65%/1000
ECO 40-60	9	-	3:48	0.952	63.2	38	53%/1350
	4.5	-	2:54	0.662	45.5	37	53%/1350
	2.5	-	2:54	0.221	31.4	22	53%/1350

## За модел HWM-M1014IVKB+++

Цикъл	Номинален капацитет в кг	Настройка на температурата °C	Продължителност на цикъла в часове и минути	Консумация на енергия в kWh/работен цикъл	Консумация на вода в литри/работен цикъл	най-висока температура (C)	Остатъчна влага в % /скорост на центрофуга в об./мин
20C	5	20	1:01	0.195	51	20	65%/1000
Cotton 60C	10	60	3:44	1.972	85	60	53%/1500
Mix	10	40	1:20	0.871	85	40	70%/800
Quick 15	2	студ	0:15	0.030	31	студ	75%/800
Bed Linen	10	4	1:48	0.920	85	40	65%/1000
ECO 40-60	10	-	3:59	1.015	70.6	38	53%/1450
	5	-	3:00	0.635	55.3	33	53%/1450
	2.5	-	3:00	0.286	38.8	22	53%/1450

- Горните данни са само за справка и данните може да се променят поради различни реални условия на употреба.
- Вентилите, дадени за програми, различни от програмата ECO 40-60, са само ориентировъчно.
- По отношение на EN 60456:2016/prA2019 C (EC)2019/2014, (EC)2019/2023, Класът на енергийна ефективност на ЕС е: B  
Програма за енергиен тест: ECO 40-60. Друго по подразбиране.  
Половин товар за 9,0 кг машина: 4,5 кг./ Половин товар за 9,0 кг машина: 2,5 кг.  
Четвъртно натоварване за 10,0 кг машина: 5,0 кг / Четвъртно натоварване за 10,0 кг машина: 2,5 кг



### Скорост на въртене

Когато е необходимо, скоростта на центрофугиране може да се регулира чрез натискане на бутона Speed в следните стъпки: 0-400-600-800-1000-1200-1400



### DELAY (Отложено включване)

Активиране на функцията за отложено включване (таймер):

1. Изберете една програма.
2. Натиснете бутона Delay (Таймер / Отложено включване) с цел настройка на времетраенето (времетраенето на таймера е между 0 и 24 часа)
3. Натиснете бутона Start/Pause с цел активиране на функцията за отложено включване (таймер).



Избиране на програма



Настройка на времетраенето



Стартиране на програмата

Анулиране на функцията за отложено включване (таймер):

Задържете натиснат бутона [Delay], докато се покаже върху екрана надпис 0H.

**PRE WASH (Предпране)**

Тази функция позволява предпране на дрехите преди основното изпиране. Тогава, когато избирате тази функция, е необходимо да поставите перилен препарат в отделение "I".

**EXTRA RINSE (Допълнително изплакване)**

Избирането на тази функция активира допълнителното изплакване на дрехите.

**Soil Level**

Времето за пране ще се увеличи или намали, след като го изберете.

**Speed Wash**

Функцията може да намали времето за пране.

**My Cycle**

Запаметяване на често използваната програма.

След като изберете програмата и зададете опциите, натиснете [Spin] 3 сек. преди да започнете прането. Курсът на настройка по подразбиране е Памук

**SpaCare**

Функцията SpaCare може да бъде избрана чрез избор на „Cotton“, „Mix“ „Bed Linen“ и "Baby Care".

Клиентите могат да видят парата в барабана, когато работят с функцията SpaCare.

**Night Wash**

Ако избраната скорост на центрофугиране е повече от 800 оборота в минута, променете на 800 оборота в минута, като междувременно отменете звука на бутона.

**ТЕМПЕРАТУРА**

Натиснете този бутон с цел настройка на температурата (Студена вода, 20°C, 40°C, 60°C, 90°C)



### ЗАЩИТА СРЕЩУ ЗАДЕЙСТВАНЕ ОТ ДЕЦА

Тази функция позволява предотвратяване на несъответстващата употреба от страна на деца. Натиснете „Temp.“ и „Function“ 3 секунди до звуков сигнал.



- Когато заключването за деца е активирано и програмата стартира, индикаторът за заключване за деца ще се включи и CL и оставащото време на дисплея се показват последователно за 0.5s.
- Натиснете останалите бутони и индикаторът за заключване за деца ще мига за 3 секунди. когато програмата завърши, CL и END се редуват за 10 секунди за 0,5 секунди, след това индикаторите за заключване за деца мигат за 3 секунди
- Само с натискане и задържане на двата бутона можете да освободите заключване за деца, дори да изключите захранването, да изключите и да завършите програмата.
- „Заключване за деца“ ще заключи всички бутони с изключение на бутона за захранване и бутона за заключване за деца.
- Моля, освободете заключването за деца, преди да изберете програма и да започнете да миете.



### ДЕЗАКТИВИРАНЕ НА ЗВУКОВОТО ПРЕДУПРЕЖДАВАНЕ



1. Изберете програмата
2. Натиснете „Spin“ за 3 секунди, зумерът е изключен. За да активирате функцията зумер, натиснете бутона отново за 3 секунди. Настройката ще се запази до следващото нулиране.

Внимание! След заглушаване на функцията зумер, звуците няма да се активират повече



### **Reload (ДОБАВЯНЕ НА ДРЕХИ ЗА ПРАНЕ ПО ВРЕМЕ НА ПРОГРАМАТА ЗА ИЗПИРАНЕ)**

Тази операция може да се извършва по време на процеса за изпиране. При високо ниво на водата, при висока температура или когато барабанът се върти, вратата остава блокирана поради причини за безопасност и добавянето на дрехи за изпиране не е възможно. Натиснете и задръжте натиснат бутона [Start/Pause] по време на 3 секунди, след това можете да добавите дрехи за пране по време на програмата за изпиране. Моля, следвайте долните стъпки:

1. Изчакайте да спре въртенето на барабана.
2. Вратата ще бъде деблокирана.
3. След добавяне на дрехите за изпиране, затворете вратата и натиснете отново бутона [Start/Pause].



## Х. ПОЧИСТВАНЕ И ПОДДРЪЖКА

**ПРЕДУПРЕЖДЕНИЕ!** Преди извършване на операциите за поддръжка, изключете пералнята от източника за захранване с електроенергия и затворете крана.

### ПОЧИСТВАНЕ НА КОРПУСА

Правилната поддръжка на пералната машина може да удължи периода за нейното използване. Тогава, когато е необходимо, повърхностите на корпуса могат да се почистват с неабразивен разреден неутрален перилен препарат. Ако водата прелее от пералнята, използвайте влажна кърпа, за да я избършете веднага. Не се позволява използването на остри предмети.

**ЗАБЕЛЕЖКА:** Използването на мравчена киселина и на разредени разтворители (етилов алкохол, химични продукти и др.) е забранено.

### ПОЧИСТВАНЕ НА ВАНАТА

Следите от ръжда, оставени във вътрешността на ваната от металните предмети, трябва да се отстранят веднага, като се използват перилни препарати, които не съдържат хлор. Не използвайте кухненски метални телчета.

**ЗАБЕЛЕЖКА:** Не поставяйте дрехи за пране във ваната по време на процедурата за почистване на ваната.

### ПОЧИСТВАНЕ НА ГУМЕНОТО УПЛЪТНЕНИЕ И НА СТЪКЛОТО НА ВРАТАТА

Избършете гуменото уплътнение и стъклото на вратата след всяко изпиране с цел отстраняване на власинките и петната. Натрупването на власинки може да причини течове. След всяко изпиране отстранявайте монетите, копчетата и други предмети от гуменото уплътнение.

### ПОЧИСТВАНЕ НА ВХОДЯЩИЯ ФИЛТЪР

**ЗАБЕЛЕЖКА:** Входящият филтър трябва да се почиства, ако количеството на водата, която е необходима за изпиране, намалява.

Почистване на филтъра при връзката с крана:

2. Затворете крана.
3. Извадете входящия маркуч от крана.
4. Почистете филтъра.
5. Свържете входящия маркуч към крана.

Почистване на филтъра при връзката с пералната машина:

1. Развийте входящия маркуч от задната страна на пералнята.
2. Извадете филтъра с помощта на клещи с дълга човка и монтирайте го на място след почистване.
3. Използвайте четка, за да почистите филтъра.
4. Свържете отново входящия маркуч.

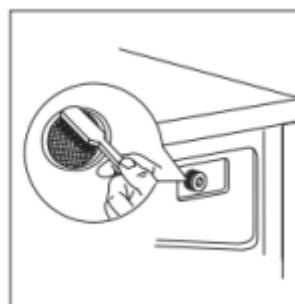
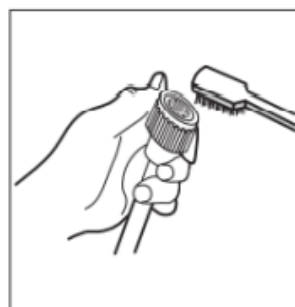
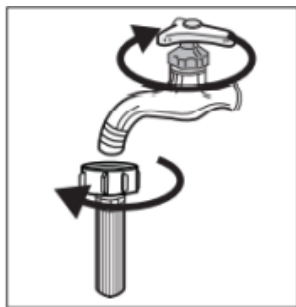

**ЗАБЕЛЕЖКА:**

- Ако не успеете да почистите филтъра с четката, той може да се отстрани и измие отделно.
- Поставете обратно филтъра и отворете крана

#### **ПОЧИСТВАНЕ НА ЧЕКМЕДЖЕТО ЗА ПЕРИЛЕН ПРЕПАРАТ**

1. Натиснете върху стрелката във вътрешността на чекмеджето за перилен препарат.
2. Вдигнете клапата и извадете капака на отделението за ароматизатор, след това измийте с вода всички отделения.
3. Поставете на място капака на отделението за ароматизатор и бутнете чекмеджето в своето гнездо.

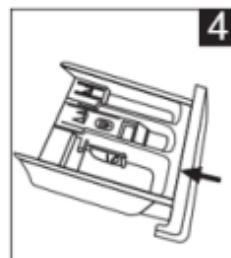
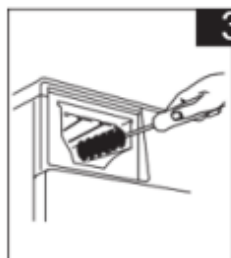
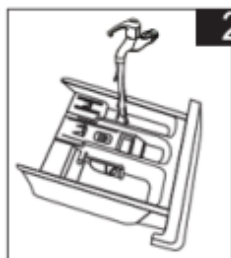

**ИЗМИЙТЕ ФИЛТЪРА НА ПОМПАТА ЗА ИЗТОЧВАНЕ ПРЕДУПРЕЖДЕНИЕ!**

Внимавайте с горещата вода! Оставете разтвора с препарат за миене да се охлади. С цел предотвратяване на риска от токов удар, изваждайте пералната машина от контакта преди почистване на филтъра.

Филтърът на помпата за извеждане може да задържа малки предмети по време на изпиране.

Почиствайте периодично филтъра, за да осигурите нормално функциониране на пералната машина

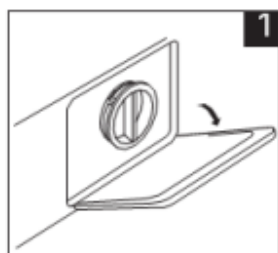

Отворете долния капак

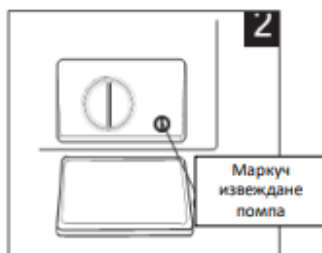

Завъртете на 90 градуса, извадете маркуча, след това извадете неговата тапа

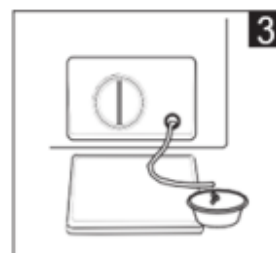

След изтичане на водата, вкарайте отново маркуча

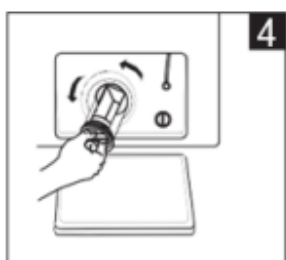

Развийте филтъра чрез въртене в обратна посока на часовниковите стрелки

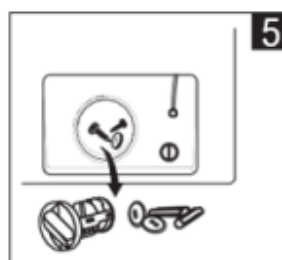

Отстранете чуждите предмети

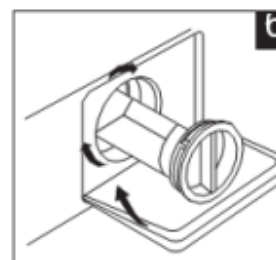

Затворете долния капак

**ВНИМАНИЕ!**

- Уверете се, че маркучът на помпата за извеждане и капакът на помпата са монтирани обратно по съответстващ начин. В противен случай могат да се появят течове на вода.
- Някои уреди не са оборудвани с маркуч на нивото на помпата за извеждане на водата, така че стъпките 2 и 3 могат да бъдат пропуснати. За уредите от този вид е достатъчно директното отваряне на долния капак.
- В зависимост от избраната програма за изпиране, съществува възможност в помпата за извеждане да има гореща вода. Не изваждайте капака на помпата по време на изпиране, изчакайте приключването на програмата за изпиране и изпразването на пералната машина. Тогава, когато поставяте капака на място, уверете се, че е стегнат добре

## XI. ОТСТРАНЯВАНЕ НА ПРОБЛЕМИ

Ако пералнята не се включва или се изключва по време на функциониране, опитайте първо да откриете проблема съгласно инструкциите от долната таблица, след това се обърнете към сервизен център.

Описание:	Причина	Решение
Пералната машина не се включва.	Вратата не е добре затворена.	Включете отново пералната машина след затваряне на вратата. Уверете се, че дрехите за изпиране не възпрепятстват затварянето на вратата.
Вратата не може да бъде отворена.	Системата за безопасност на пералнята е активирана.	Изключете и включете отново захранването с електроенергия.
Течове на вода	Връзките на входящия маркуч или на маркуча за извеждане не са стегнати достатъчно.	Проверете и стегнете добре връзките. Почистете маркуча за извеждане.
Има остатъци от перилен препарат в чекмеджето.	Перилният препарат е влажен или в него са се образували бучки.	Почистете и избършете чекмеджето за перилен препарат.
Светлинните индикатори или екранът не работят.	Проблеми със захранването с електроенергия.	Уверете се, че захранването е включено и че щепселът е свързан правилно.
Необичайни шумове.	Фиксиращите болтове все още са на мястото си. Подът не е здрав или равен.	Уверете се, че болтовете за фиксиране са отстранени. Уверете се, че пералнята е поставена върху здрав и равен под.

### КОДОВЕ ЗА ГРЕШКИ

Описание:	Причина	Решение
E30	Вратата не е добре затворена.	Включете отново пералната машина след затваряне на вратата. Уверете се, че дрехите за изпиране не възпрепятстват затварянето на вратата.
E10	Проблеми с изпускането на водата по време на изпиране	Уверете се, че налягането на захранването с вода не е твърде ниско. Изправете входящия маркуч. Проверете маркуча за подаване на вода. Уверете се, че входящият маркуч не е запушен.
E21	Извеждането на водата не е съответстващо.	Уверете се, че маркучът за извеждане не е запушен.
E12	Прекомерно количество вода.	Включете отново пералната машина.
EXX	Други	Извършвайте всички необходими проверки, след това се обърнете към сервизен център.

**Изхвърляне на отпадъците по начин, отговорен за околната среда**

Можете да помогнете за опазването на околната среда!

Моля спазвайте местните разпоредби: Предайте нефункциониращото електрическо оборудване



**HEINNER** е регистрирана марка на компанията **Network One Distribution SRL**. Останалите търговски марки и наименованията на продуктите са търговски марки или регистрирани търговски марки на съответните им притежатели.

Нито една част от спецификациите не може да бъде възпроизвеждана под каквато и да е форма или средство, или използвана за получаване на производни като преводи, трансформации или адаптации, без предварителното съгласие на компанията NETWORK ONE DISTRIBUTION.

Copyright © 2013 Network One Distribution. Всички права запазени.

[www.heinner.com](http://www.heinner.com), <http://www.nod.ro>



Този продукт е проектиран и произведен в съответствие със стандартите и нормите на Европейската общност.

Вносител: **Network One Distribution**

ул. Марчел Янку № 3-5, Букурещ, Румъния

Тел: +40 21 211 18 56, [www.heinner.com](http://www.heinner.com), [www.nod.ro](http://www.nod.ro)

# HEINNER

Automata mosógép

Modell:

HWM-M914IVKB+++ / HWM-M1014IVKB+++



- Automata mosógép
- Mosási kapacitás: 9/10kg
- Energiahatékonysági besorolás: B

Thank you for purchasing this product!

## II. BEVEZETÉS

***A készülék használata előtt olvassa el figyelmesen a használati kézikönyvet, és őrizze meg későbbi tanulmányozásra.***

A kézikönyvet azért szerkesztettük, hogy rendelkezésére bocsássunk a készülék üzembe helyezésére, használatára és karbantartására vonatkozó minden szükséges utasítást a.

A készülék helyes és biztonságos használata érdekében, az üzembe helyezés és használat előtt kérjük, olvassa el figyelmesen a használati kézikönyvet.

## II. A CSOMAG TARTALMA



- Mosógép
- Használati kézikönyv
- Garancialevél

### III. BIZTONSÁGI UTASÍTÁSOK

A biztonságos működtetés érdekében, kérjük, kövesse jelen útmutatóban található utasításokat, hogy minimálisra csökkenthesse a tűzveszély, robbanás vagy áramütés kockázatát és megelőzhesse az anyagi károkat és a súlyos vagy halálos személyi sérüléseket. A szimbólumok jelentése:

**Figyelmeztetés!** Ez a figyelmeztető szimbólum és szó kombináció olyan lehetséges veszélyhelyzetekre utal, melyek súlyos vagy halálos személyi sérüléseket okozhatnak.

**Figyelem!** Ez a figyelmeztető szimbólum és szó kombináció olyan lehetséges veszélyhelyzetekre utal, melyek kis vagy könnyű személyi sérüléseket okozhatnak, vagy jelentős anyagi károk keletkezéséhez, illetve környezetkárosításhoz vezethetnek.

**Jegyezze meg!** Ez a figyelmeztető szimbólum és szó kombináció olyan lehetséges veszélyhelyzetekre utal, melyek kis vagy könnyű személyi sérüléseket okozhatnak.

#### **Figyelmeztetés!**

**Áramütés veszély!** A vészhelyzetek megelőzése érdekében, amennyiben a készülék tápkábele károsodás jeleit mutatja, annak cseréjét a gyártó, az általa jóváhagyott szervizek és műhelyek vagy szakirányú képzettséggel rendelkező személy végezhetik.

Kérjük, használja a készülékkel együtt szállított új tömlőket. A régi tömlők nem hasznosíthatók.

- Bármilyen jellegű karbantartási munkálat megkezdése előtt, kérjük, húzza ki a készülék tápkábelének dugaszát a villamoshálózat aljzatából.
- A berendezés minden egyes használata után kérjük, kapcsolja le a berendezést a hálózatról és zárja el a berendezés vízellátását is.
- A biztonságos használat érdekében a berendezés tápkábelének dugaszát hárompólusú, földeléssel ellátott hálózati aljzatba kell csatlakoztatni. Figyelmesen ellenőrizze és bizonyosodjon meg afelől, hogy az aljzat a földeléshez megfelelően van csatlakoztatva.
- Bizonyosodjon meg afelől, hogy a gyártó által előírt biztonsági utasításoknak, illetve a helyileg hatályos biztonsági előírásoknak megfelelően, a készüléknek a villamosenergia- és a vízhálózatához történő csatlakoztatása szakképzett személy által történik.

Gyermekek esetleges sérüléséhez vezető veszélyforrás!

Ezt a berendezést 8 évnél idősebb gyermekek vagy korlátolt fizikai, érzékszervi és mentális képességekkel rendelkező személyek csak felügyelet alatt vagy annak rendeltetészerű és biztonságos használatára irányuló kiképzés után használhatják, amennyiben annak használatával járó veszélyeket megértették.

Gyermekek számára a berendezéssel játszani szigorúan tilos. A tisztítási és karbantartási műveleteket gyermekek csak felnőtt jelenlétében végezhetik.

3 év alatti gyerekek jelenlétében fokozottan figyeljen, hogy azok ne játszhassanak a készülékkel. Bizonyosodjon meg afelől, hogy gyerekek vagy háziállatok nem kerültek a készülék belsejébe. Minden egyes használat előtt ellenőrizze a berendezést.

Gyermekek jelenlétében fokozottan figyeljen, hogy azok ne játszhassanak a készülékkel.



A készülék használata során az üvegajtó magas hőmérsékletre is felforrósodhat. A működés során, amennyiben az nedves környezetben vagy robbanásveszélyes, gyúlékony vagy maró anyagok jelenlétében történik, ne engedjen gyermekeket vagy háziállatokat a készülék közelébe.

A berendezés üzembe helyezése előtt távolítsa el annak csomagolást, illetve szállításkor használt rögzítő csavarokat, ellenkező esetben ezek súlyos veszélyhelyzethez vezethetnek. A dugaszt a készülék üzembe helyezésekor könnyen hozzáférhetővé kell tenni.

### **Robbanásveszély!**

Ne mosson és ne szárítson olyan darabokat, melyeket tűz- vagy robbanásveszélyes anyagokkal áztatott át (viasz, olajak, festékanyagok, benzin, zsírolajok, vegyiparban használatos oldószerek, kerozin, stb.), mivel fennáll a tűz keletkezésének és a robbanások kockázata. Mielőtt a mosógépbe helyezné, előzetesen kézzel alaposan öblítse át őket.

### **A készülék beszerelése:**

A készüléket kizárólag beltéri használatra tervezték.

A berendezés nem használható beépített készülékként.

Ne tömítse el a berendezés nyílásait textilanyagokkal vagy egyéb tárgyakkal.

A mosógép elhelyezése nem javasolt nedves, valamint robbanékony gázok és maró hatású vegyi anyagok tárolására szánt helyiségekben.

Egyetlen bemeneti csővel felszerelt mosógépeket kizárólag hideg vízforrásra lehet csatlakoztatni. Kettős bemeneti csővel rendelkező mosógépeket hideg- és meleg vízforrásra egyaránt kell csatlakoztatni.

A dugaszt a készülék üzembe helyezésekor könnyen hozzáférhetővé kell tenni.

### **BIZTONSÁGRA VONATKOZÓ UTASÍTÁSOK**

A berendezés üzembe helyezése előtt távolítsa el annak csomagolását, illetve a szállításkor rögzítő csavarokat, ellenkező esetben ezek súlyos veszélyhelyzethez vezethetnek.

#### **A készülék károsodásához vezető veszélyforrások!**

Az Ön mosógépét kizárólag háztartási célú felhasználásra tervezték és csak géppel mosható textilanyagok tisztítására használható.

- Ne másszon fel, illetve ne álljon és ne üljön rá a mosógép tetőlemezeire.
- Ne támaszkodjon rá a mosógép ajtajára.
- A gép mozgatása során felmerülő veszélyek megelőzésére vonatkozó intézkedések:
  1. A szállításkor használatos rögzítő csavarok visszaszerelését csak szakember végezheti.
  2. A gép belső terében felgyűlt vizet le kell engedni a készülékből.
  3. Óvatosan mozgassa a készüléket. A berendezés emelése során ne annak kiálló részeit ragadja meg. A készülék mozgatása során ne használja a berendezés ajtaját fogantyúként.
  4. A készülék súlyos. Szállítását és mozgatását kellő figyelemmel végezze.

Az ajtó becsukásánál nem indokolt túlzott erő használata. Amennyiben az ajtó nehezen záródik, vizsgálja meg a behelyezett ruhamennyiséget vagy annak eloszlását.

**A berendezés használata:**

Mielőtt a készüléket első alkalommal használná mosásra, annak egy teljes mosási ciklust kell teljesítenie ruhák nélkül.

Tilos a robbanásveszélyes, gyúlékony vagy mérgező anyagok használata a mosásnál. A benzin és alkohol nem használható mosószerként. Kérjük, hogy a mosás során kizárólag a készülék számára előírt mosószereket használjon.

Mosás előtt, kérjük, ellenőrizze, hogy a ruhák zsebei üresek-e. Az olyan éles és szilárd tárgyak, mint a fémpénzek, kitűzők, szegek, csavarok és kődarabok súlyos meghibásodásokat okozhatnak.

A készülék ajtajának kinyitása előtt bizonyosodjon meg róla, hogy annak belsejéből az összes víz kiürült. Amennyiben a berendezés belsejében víz jelenlétét észleli, ne nyissa ki annak ajtaját.

Vigyázzon, hogy ne forrázza le magát, amikor a berendezésből a forró víz kifolyik.

A mosás során ne próbálja kézzel pótolni a vizet.

A mosási program befejezése után, kérjük, várjon két percet mielőtt a készülék ajtaját kinyitná.

## IV. A KÉSZÜLÉK BESZERELÉSE

### A beszerelés helye

A berendezés stabilitása elsődleges kérdés annak érdekében, hogy a berendezésnek a működés során történő mozgását megelőzhessük.

Bizonyosodjon meg afelől, hogy a készülék nem a villamos tápkábelben fekszik.

Mielőtt a készüléket beszerelné, olyan helyet válasszon neki, amely az alábbi sajátosságokkal rendelkezik:

1. Kemény, egyenletesen sima és száraz tartófelülettel rendelkezik.
2. Nincs kitéve közvetlenül napfény hatásának.
3. Bizonyosodjon meg róla, hogy a hely megfelelően szellőztethető.
4. A helyiség hőmérséklete mindig meghaladja a 5 °C értéket.
5. Ne helyezze olyan közvetlen hőforrások közelébe, mint amilyenek a szén- vagy gáz üzemanyaggal működő fűtőtestek.

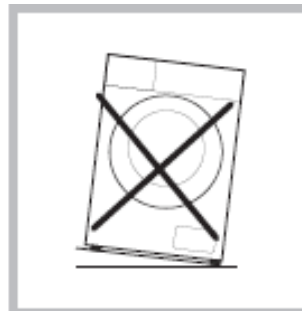
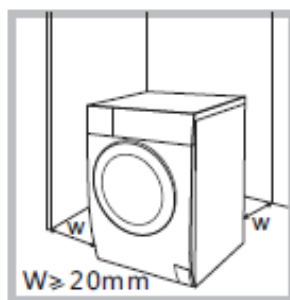

### A mosógép kicsomagolása

A készülék csomagolása (fóliák, polisztirol, stb.) veszélyt jelent a kisgyermek számára.

Fulladásveszély! Ne hagyja, hogy a gyerekek hozzáférhessenek a csomagolóanyagokhoz.

Távolítsa el a kartondobozt és a polisztirol védőlemezeket.

### A mosógép stabilizálása

1. A négy láb anyacsavarjait szorítsa megfelelően a gépházra.

Bizonyosodjon meg róla, hogy a lábakat megfelelően rögzítették a gépházhoz. Ellenkező esetben helyezze azokat az eredeti helyzetükbe, majd szorítsa meg az anyacsavarokat.

2. Lazítsa ki a rögzítő anyacsavarokat és addig forgassa a lábakat, amíg azok a padlót érintik.

3. Állítsa be a lábakat, majd bizonyosodjon meg róla, hogy a készülék stabilan áll.

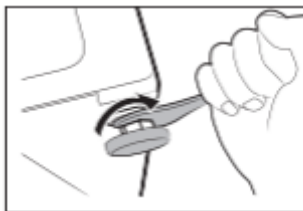

### A szállítási rögzítő csavarok eltávolítása

A berendezés működésbe helyezése előtt elengedhetetlenül szükséges a készülék hátsó részébe szerelt szállító rögzítő csavarok eltávolítása.

Mivel a készülék szállítása esetén a rögzítő csavarokra szükség lehet, javasolt azoknak egy megfelelően biztonságos helyen történő tárolása.

Az alább felsorolt lépéseknek megfelelően járjon el:

1. Csavarkulcs segítségével először lazítsa ki, csavarja ki és távolítsa el mind a négy csavart.
2. A csavarhelyek nyílásait a tartozékként szállított védődugókkal zárja el.
3. Későbbi használat esetére őrizze meg a rögzítő csavarokat

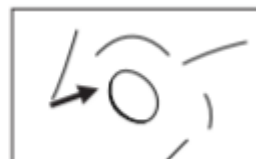

### Csatlakoztassa a vízellátó tömlőt

A szivárgás vagy vízkárok elkerülése érdekében kövesse az ebben a fejezetben található utasításokat.

- Ne törje meg, törje össze vagy módosítsa a vízbevezető tömlőt

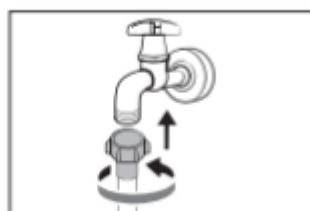
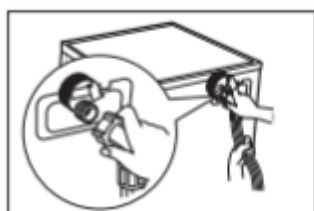

### Leeresztő tömlő

Ne hajlítsa meg vagy csavarja meg a kifolyót.

Szerelje fel megfelelően a vízkivezető csövet. Ellenkező esetben vízszivárgás okozta meghibásodások léphetnek fel.

A kifolyócső kétféleképpen szerelhető fel:

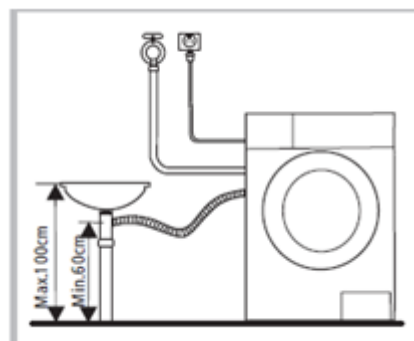
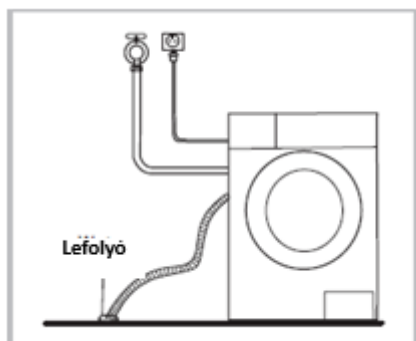

## V. A KÉSZÜLÉK LEÍRÁSA

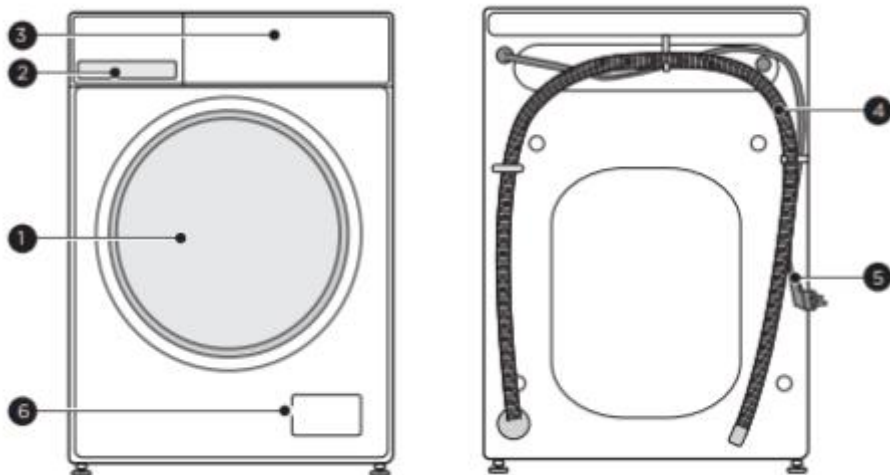

1. Ajtó	4. Víz kifolyócsöve
2. Mosószer adagoló rekesze	5. Villamos tápkábel
3. Irányítópanel	6. Szűrő

## Tartozékok



4x Szállítási védődugók  
 1x Hidegvíz befolyó csöve  
 1x Használati utasítás

## VI. A KÉSZÜLÉK MŰKÖDÉSE

### Gyors indítás

Mielőtt üzembe helyezné a készüléket, bizonyosodjon meg annak megfelelő beszereléséről.

Mielőtt először mosna ruhákat, a gépnek előzetesen egy teljes mosási ciklust kell teljesítenie üresen, szennyes ruhák nélkül

### Mosás előtt

Dugja be a dugaszt az aljzatba  
Nyissa meg a csapot  
Helyezze a ruhákat a gép belsejébe  
Zárja be az ajtót  
Tegyen be mosószer

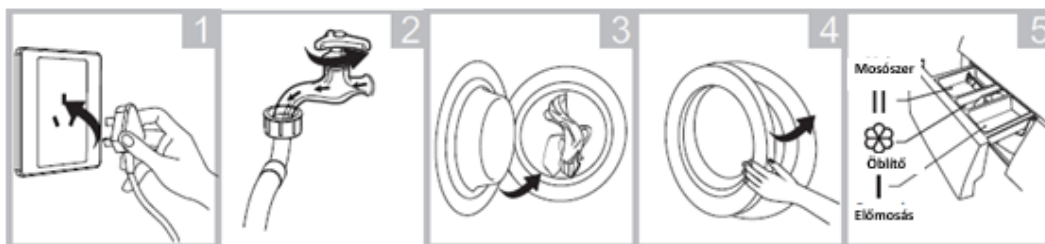

### Mosás

Válassza ki a programot  
Válassza ki az óhajtott kiegészítő funkciókat  
Indítsa el a mosási programot

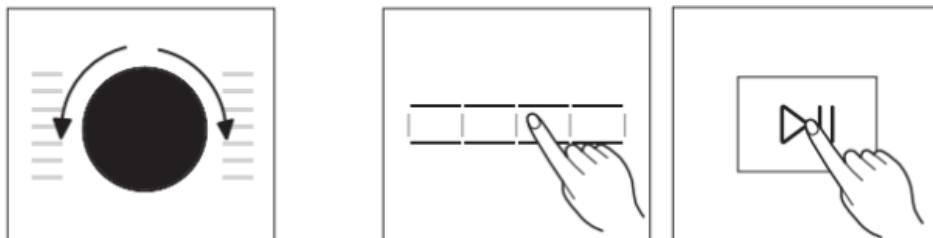

Amennyiben az implicit mosási programot választotta, a 3. lépés átugorható.

### Mosás után

Először egy hangjelzés hallható, majd a kijelzőn az „End” felirat jelenik meg.

## VII. KEZELŐPANEL

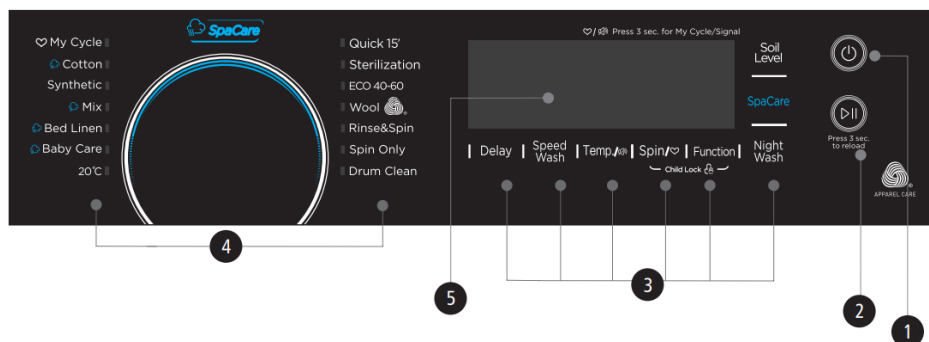
**1. On/Off (Bekapcsolás/Kikapcsolás)**

A mosógép ki- és bekapcsolására szolgáló gomb.

**2. Start/Pause (Indítás/Megszakítás)**

A kiválasztott mosási program elindítására/megszakítására szolgáló gomb.

**3. Opciók**

Ezek a gombok teszik lehetővé a további funkciók kiválasztását.

**4. Programok**

A mosandó ruhák függvényében választható programok.

**5. Kijelző**

A kijelző megjeleníti a beállításokat, a kiválasztott program végéig hátralevő időt, az aktív opciókat és a mosógép állapotára vonatkozó üzeneteket.

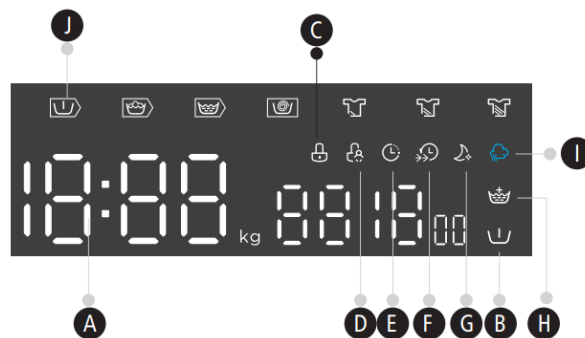
**Kijelző**

A – Kijelző	F - Gyorsmosás
B - Előmosás	G - Night Wash
C - Ajtózár	H - Extra öblítés
D - Gyerekzár	I - SpaCare
E - Késleltetés	J - Előmosás-mosás-öblítés-centrifugálás

## VIII. HASZNÁLATI UTASÍTÁSOK

**Minden mosás előtt**

A mosógép működése során a környezet hőmérséklete legyen a 5-40°C értéktartományban. Amennyiben a készüléket egy olyan helyiségben tárolja, melynek hőmérséklete 0 °C vagy annál alacsonyabb, a készüléket át kell költöztetni egy olyan helyiségbe, ahol a felhasználó biztos lehet abban, hogy a víz be- és kifolyócsöve nem fagy be a készülék használata előtt. Mosás előtt, kérjük, figyelmesen olvassa el a ruhák címkéin található és a mosószerre vonatkozó információkat. Használjon olyan habzásmentes vagy csökkentett habzású mosószereket, melyek a mosógép számára megfelelőek.



Olvassa el a ruha címkéjén feltüntetett információkat



Uritse ki teljesen a zsebeket

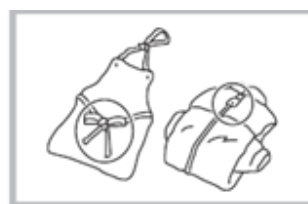

Kötözze össze a hosszú köteleket, húzza fel a cipzárokat és gombolja be a gombokat



Az apró mosnivalót helyezze egy párnahuzatba vagy egy kis mosószácba



Fordítsa ki azokat a ruhadarabokat, melyek könnyen pihésednek vagy hosszú szálakból készültek

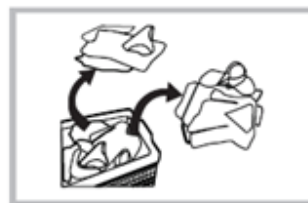

Válassza szét a különböző textiliákból készült ruhadarabokat

**Figyelmeztetés!**

Egyetlen darab szennyes ruhadarab mosása esetén a készülék forgódobja nem megfelelően működhet a kiegyensúlyozatlan eloszlás miatt. Ezért több ruhadarab egyidejű mosását ajánljuk, hogy a forgódob ürítése megfelelő módon történhessen.

Ne mosson a készülékkel olyan ruhadarabokat, melyek kerozinnal, benzinnel, alkohollal vagy egyéb gyúlékony anyagokkal érintkeztek.



### Mosószer tartó rekesz

- I Előmosószer számára fenntartott fiók
- II Mosószer számára fenntartott fiók
- Öblítőszer számára fenntartott fiók
- Az adagoló kihúzásához engedje el a gombot

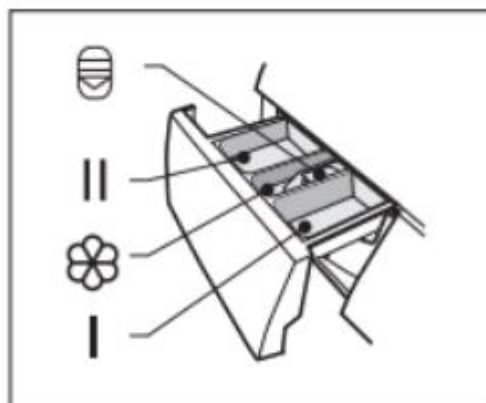

### Figyelem!

Az I fiók feltöltése csak az előmosás funkcióval ellátott készülékek esetén szükséges és csak amennyiben a felhasználó az előmosás funkció használata mellett dönt.

Program	I	II/△	Öblítőszer	Program	I	II/△	Öblítőszer
Cotton	<input type="radio"/>	<input checked="" type="radio"/>	<input type="radio"/>	Spin Only			<input type="radio"/>
Synthetic	<input type="radio"/>	<input checked="" type="radio"/>	<input type="radio"/>	Rinse&Spin			<input type="radio"/>
Mix	<input type="radio"/>	<input checked="" type="radio"/>	<input type="radio"/>	Wool		<input checked="" type="radio"/>	<input type="radio"/>
Bed Linen	<input type="radio"/>	<input checked="" type="radio"/>	<input type="radio"/>	ECO 40-60		<input checked="" type="radio"/>	<input type="radio"/>
Baby care	<input type="radio"/>	<input checked="" type="radio"/>	<input type="radio"/>	Sterilization		<input checked="" type="radio"/>	<input type="radio"/>
20 C	<input type="radio"/>	<input checked="" type="radio"/>	<input type="radio"/>	Quick 15'		<input checked="" type="radio"/>	<input type="radio"/>
Drum clean		<input checked="" type="radio"/>	<input type="radio"/>				<input type="radio"/>

- Hozzáadása kötelező
- Hozzáadása választás szerint

- Kérjük, válassza ki a megfelelő típusú mosószert a maximális mosási teljesítmény és a minimális víz- és energiafogyasztás.
- A legjobb tisztítási eredmény eléréséhez fontos a megfelelő mosószer adagolás.
- Használjon csökkentett mennyiségű mosószert, ha a dob nincs teljesen feltöltve.
- A mosószer mennyiségét mindig a víz keménységéhez igazítsa, ha a csapvíz lágy, használja kevesebb mosószert.
- A ruhanemű szennyezettségének megfelelően adagolja, a kevésbé koszos ruhákhoz kevesebb mosószerre van szükség.
- Az erősen koncentrált (kompakt mosószer) különösen pontos adagolást igényel.

A következő tünetek a mosószer-túladagolás jelei:





- erős habképződés
- gyenge mosási és öblítési eredmény





A következő tünetek a mosószer adagolása alatti jelei:

- a ruhanemű megszurkúl
- vízkőlerakódások a dobon, a fűtőelemen és/vagy a ruhaneműn

## IX. PROGRAMOK HASZNÁLATA

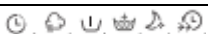
## Modellhez HWM-M1014IVKB+++





<b>Cotton</b>	
Mosási hőmérséklet	Hideg, 20°C, 30°C, 40°C, 60°C, 90°C
Maximális száraz ruha mennyiség	10 kg
Centrifugálási sebesség kiválasztása (rpm)	0, 400, 600, 800, 1000, 1200, 1400
További funkciók	
A program alapértelmezett időtartama	03:39
Ruhatípus/leírás	Hő és gyűrődésálló ruhadarabok, melyek pamutból vagy vászonszövetből készültek.
<b>Synthetic</b>	
Mosási hőmérséklet	Hideg, 20°C, 30°C, 40°C, 60°C
Maximális száraz ruha mennyiség	5 kg
Centrifugálási sebesség kiválasztása (rpm)	0, 400, 600, 800, 1000, 1200
További funkciók	
A program alapértelmezett időtartama	03:18
Ruhatípus/leírás	Szintetikus anyagokból készült ruhadarabok mosására ajánlott: blúzok, dzsekik, műszálás keverékek, stb. Kötöttáru mosása esetén a túlzott habképződés megelőzése érdekében csökkenteni kell a használandó mosószer mennyiségét
<b>Baby Care</b>	
Mosási hőmérséklet	Hideg, 20°C, 30°C, 40°C, 60°C, 90°C
Maximális száraz ruha mennyiség	10 kg
Centrifugálási sebesség kiválasztása (rpm)	0, 400, 600, 800, 1000, 1200, 1400
További funkciók	
A program alapértelmezett időtartama	01:42
Ruhatípus/leírás	Ez a program kisbabák ruháinak mosására ajánlott, ezáltal biztosítva a babaruhák optimális tisztítása mellett azok hatékonyabb öblítését is, mely jobban kíméli a kicsik bőrét
<b>Bed Linen</b>	
Mosási hőmérséklet	Hideg, 20°C, 30°C, 40°C, 60°C
Maximális száraz ruha mennyiség	10 kg
Centrifugálási sebesség kiválasztása (rpm)	0, 400, 600, 800, 1000, 1200, 1400
További funkciók	
A program alapértelmezett időtartama	01:48
Ruhatípus/leírás	Ezt a programot kifejezetten paplanok mosására fejlesztették ki.





<b>Mix</b>	
Mosási hőmérséklet	Hideg, 20°C, 30°C, 40°C, 60°C, 90°C
Maximális száraz ruha mennyiség	10 kg
Centrifugálási sebesség kiválasztása (rpm)	0, 400, 600, 800, 1000, 1200, 1400
További funkciók	
A program alapértelmezett időtartama	01:20
Ruhatípus/leírás	Vegyes összetételű szennyes, pamutot és műszálas anyagot is tartalmaz.
<b>20°C</b>	
Mosási hőmérséklet	Hideg, 20°C
Maximális száraz ruha mennyiség	5 kg
Centrifugálási sebesség kiválasztása (rpm)	0, 400, 600, 800, 1000, 1200
További funkciók	
A program alapértelmezett időtartama	01:01
Ruhatípus/leírás	Az élénk színű ruhák mosása jobban megvédi a színeket.
<b>Sterilization</b>	
Mosási hőmérséklet	70°C
Maximális száraz ruha mennyiség	5 kg
Centrifugálási sebesség kiválasztása (rpm)	0, 400, 600, 800, 1000, 1200
További funkciók	
A program alapértelmezett időtartama	02:27
Ruhatípus/leírás	Tartsa a mosási hőmérsékletet 60 fok felett több mint 30 perc, hatékonyan távolítja el a káros baktériumokat
<b>Quick 15'</b>	
Mosási hőmérséklet	Hideg, 20°C, 30°C
Maximális száraz ruha mennyiség	2 kg
Centrifugálási sebesség kiválasztása (rpm)	0, 400, 600, 800
További funkciók	
A program alapértelmezett időtartama	00:15
Ruhatípus/leírás	Ez a program kiválóan megfelel kisebb mennyiségű és kevésbé szennyezett ruhák mosására.
<b>Wool</b>	
Mosási hőmérséklet	Hideg, 20°C, 30°C, 40°C
Maximális száraz ruha mennyiség	2 kg
Centrifugálási sebesség kiválasztása (rpm)	0, 400, 600, 800
További funkciók	
A program alapértelmezett időtartama	01:07
Ruhatípus/leírás	Olyan gyapjú ruhadarabok mosására alkalmas program, melyek kézi vagy gépi mosás útján tisztíthatók. Kímélő program, melyet az anyagnak a túlzott vízmennyiség következtében fellépő összemenésének megelőzése érdekében fejlesztettek ki

<b>Spin Only</b>	
Mosási hőmérséklet	--
Maximális száraz ruha mennyiség	10 kg
Centrifugálási sebesség kiválasztása (rpm)	0, 400, 600, 800, 1000, 1200, 1400
További funkciók	
A program alapértelmezett időtartama	00:12
Ruhatípus/leírás	Extra centrifugálás, kiegészítve a centrifugálási fordulatszám előzetes kiválasztásának lehetőségével.
<b>Rinse &amp; Spin</b>	
Mosási hőmérséklet	--
Maximális száraz ruha mennyiség	10 kg
Centrifugálási sebesség kiválasztása (rpm)	0, 400, 600, 800, 1000, 1200, 1400
További funkciók	
A program alapértelmezett időtartama	00:20
Ruhatípus/leírás	További öblítés, centrifugálással.
<b>ECO 40-60</b>	
Mosási hőmérséklet	--
Maximális száraz ruha mennyiség	10 kg
Centrifugálási sebesség kiválasztása (rpm)	1400
További funkciók	
A program alapértelmezett időtartama	03:59
Ruhatípus/leírás	Élénk színű ruhákat mosva jobban védi a színeket. Alapértelmezett 40 C, nem választható, kb. 40 C - 60 C közötti mosásra alkalmas
<b>Drum Clean</b>	
Mosási hőmérséklet	90°C
Maximális száraz ruha mennyiség	0 kg
Centrifugálási sebesség kiválasztása (rpm)	--
További funkciók	
A program alapértelmezett időtartama	01:18
Ruhatípus/leírás	Speciálisan beállítva ebben a gépben a dob és a cső tisztítására. 90 °C-os magas hőmérsékletű sterilizálást alkalmaz, hogy zöldebbé tegye a mosandó ruhákat. A program végrehajtásakor a ruhákat vagy egyéb mosószereket nem lehet hozzáadni. Ha megfelelő mennyiségű klóros fehérítőszerrel visz be, a hordótisztító hatás jobb lesz. Az ügyfél ezt a programot igény szerint rendszeresen használhatja.

 - Delay
  - Spa Care,
  - Pre-Wash,
  - Extra rinse,
  -Night Wash,
  -Speed Wash

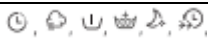
**Modellhez HWM-M914IVKB+++**

<b>Cotton</b>	
Mosási hőmérséklet	Hideg, 20°C, 30°C, 40°C, 60°C, 90°C
Maximális száraz ruha mennyiség	9 kg
Centrifugálási sebesség kiválasztása (rpm)	0, 400, 600, 800, 1000, 1200, 1400
További funkciók	
A program alapértelmezett időtartama	03:39
Ruhatípus/leírás	Hő és gyűrődésálló ruhadarabok, melyek pamutból vagy vászonszövetből készültek.
<b>Synthetic</b>	
Mosási hőmérséklet	Hideg, 20°C, 30°C, 40°C, 60°C
Maximális száraz ruha mennyiség	4.5 kg
Centrifugálási sebesség kiválasztása (rpm)	0, 400, 600, 800, 1000, 1200
További funkciók	
A program alapértelmezett időtartama	03:18
Ruhatípus/leírás	Szintetikus anyagokból készült ruhadarabok mosására ajánlott: blúzok, dzsekik, műszálás keverékek, stb. Kötöttáru mosása esetén a túlzott habképződés megelőzése érdekében csökkenteni kell a használandó mosószer mennyiségét
<b>Baby Care</b>	
Mosási hőmérséklet	Hideg, 20°C, 30°C, 40°C, 60°C, 90°C
Maximális száraz ruha mennyiség	9 kg
Centrifugálási sebesség kiválasztása (rpm)	0, 400, 600, 800, 1000, 1200, 1400
További funkciók	
A program alapértelmezett időtartama	01:42
Ruhatípus/leírás	Ez a program kisbabák ruháinak mosására ajánlott, ezáltal biztosítva a babaruhák optimális tisztítása mellett azok hatékonyabb öblítését is, mely jobban kíméli a kicsik bőrét
<b>Bed Linen</b>	
Mosási hőmérséklet	Hideg, 20°C, 30°C, 40°C, 60°C
Maximális száraz ruha mennyiség	9 kg
Centrifugálási sebesség kiválasztása (rpm)	0, 400, 600, 800, 1000, 1200, 1400
További funkciók	
A program alapértelmezett időtartama	01:48
Ruhatípus/leírás	Ezt a programot kifejezetten paplanok mosására fejlesztették ki.

<b>Mix</b>	
Mosási hőmérséklet	Hideg, 20°C, 30°C, 40°C, 60°C, 90°C
Maximális száraz ruha mennyiség	9 kg
Centrifugálási sebesség kiválasztása (rpm)	0, 400, 600, 800, 1000, 1200, 1400
További funkciók	
A program alapértelmezett időtartama	01:20
Ruhatípus/leírás	Vegyes összetételű szennyes, pamutot és műszál anyagot is tartalmaz.
<b>20°C</b>	
Mosási hőmérséklet	Hideg, 20°C
Maximális száraz ruha mennyiség	4.5 kg
Centrifugálási sebesség kiválasztása (rpm)	0, 400, 600, 800, 1000, 1200
További funkciók	
A program alapértelmezett időtartama	01:01
Ruhatípus/leírás	Az élénk színű ruhák mosása jobban megvédi a színeket.
<b>Sterilization</b>	
Mosási hőmérséklet	70°C
Maximális száraz ruha mennyiség	4.5 kg
Centrifugálási sebesség kiválasztása (rpm)	0, 400, 600, 800, 1000, 1200
További funkciók	
A program alapértelmezett időtartama	02:27
Ruhatípus/leírás	Tartsa a mosási hőmérsékletet 60 fok felett több mint 30 perc, hatékonyan távolítja el a káros baktériumokat
<b>Quick 15'</b>	
Mosási hőmérséklet	Hideg, 20°C, 30°C
Maximális száraz ruha mennyiség	2 kg
Centrifugálási sebesség kiválasztása (rpm)	0, 400, 600, 800
További funkciók	
A program alapértelmezett időtartama	00:15
Ruhatípus/leírás	Ez a program kiválóan megfelel kisebb mennyiségű és kevésbé szennyezett ruhák mosására.
<b>Wool</b>	
Mosási hőmérséklet	Hideg, 20°C, 30°C, 40°C
Maximális száraz ruha mennyiség	2 kg
Centrifugálási sebesség kiválasztása (rpm)	0, 400, 600, 800
További funkciók	
A program alapértelmezett időtartama	01:07
Ruhatípus/leírás	Olyan gyapjú ruhadarabok mosására alkalmas program, melyek kézi vagy gépi mosás útján tisztíthatók. Kímélő program, melyet az anyagnak a túlzott vízmennyiség következtében fellépő összemenésének megelőzése érdekében fejlesztettek ki

<b>Spin Only</b>	
Mosási hőmérséklet	--
Maximális száraz ruha mennyiség	9 kg
Centrifugálási sebesség kiválasztása (rpm)	0, 400, 600, 800, 1000, 1200, 1400
További funkciók	
A program alapértelmezett időtartama	00:12
Ruhatípus/leírás	Extra centrifugálás, kiegészítve a centrifugálási fordulatszám előzetes kiválasztásának lehetőségével.
<b>Rinse &amp; Spin</b>	
Mosási hőmérséklet	--
Maximális száraz ruha mennyiség	9 kg
Centrifugálási sebesség kiválasztása (rpm)	0, 400, 600, 800, 1000, 1200, 1400
További funkciók	
A program alapértelmezett időtartama	00:20
Ruhatípus/leírás	További öblítés, centrifugálással.
<b>ECO 40-60</b>	
Mosási hőmérséklet	--
Maximális száraz ruha mennyiség	9 kg
Centrifugálási sebesség kiválasztása (rpm)	1400
További funkciók	
A program alapértelmezett időtartama	03:48
Ruhatípus/leírás	Élénk színű ruhákat mosva jobban védi a színeket. Alapértelmezett 40 C, nem választható, kb. 40 C - 60 C közötti mosásra alkalmas
<b>Drum Clean</b>	
Mosási hőmérséklet	90°C
Maximális száraz ruha mennyiség	0 kg
Centrifugálási sebesség kiválasztása (rpm)	--
További funkciók	
A program alapértelmezett időtartama	01:18
Ruhatípus/leírás	Speciálisan beállítva ebben a gépben a dob és a cső tisztítására. 90 °C-os magas hőmérsékletű sterilizálást alkalmaz, hogy zöldebbé tegye a mosandó ruhákat. A program végrehajtásakor a ruhákat vagy egyéb mosószereket nem lehet hozzáadni. Ha megfelelő mennyiségű klóros fehérítőszerrel vizet visz be, a hordótisztító hatás jobb lesz. Az ügyfél ezt a programot igény szerint rendszeresen használhatja.

 - Delay
  - Spa Care,
  - Pre-Wash,
  - Extra rinse,
  - Night Wash,
  - Speed Wash



## Modellhez HWM-M914IVKB+++

Ciklus	Névl eges kapa citás	Hőmérs éklet beállítá sok C	Ciklus időtartam a	Energiafo gyasztás Kwh/cikl usban	Vízfogyasztá s Kwh/ciklus	Legma gasab b hőmé rsékle t (C)	Maradék nedvesség %/centrifugálá si sebesség rpm-ben
20C	4.5	20	1:01	0.189	48	20	65%/1000
Cotton 60C	9	60	3:44	1.734	78	60	53%/1400
Mix	9	40	1:20	0.813	78	40	80%/800
Quick 15	2	Hideg	0:15	0.030	31	Hideg	70%/800
Bed Linen	9	40	1:48	0.862	78	40	65%/1000
ECO 40-60	9	-	3:48	0.952	63.2	38	53%/1350
	4.5	-	2:54	0.662	45.5	37	53%/1350
	2.5	-	2:54	0.221	31.4	22	53%/1350

## Modellhez HWM-M1014IVKB+++

Ciklus	Névl eges kapa citás	Hőmérs éklet beállítá sok °C	Ciklus időtartam a	Energiafo gyasztás Kwh/cikl usban	Vízfogyasztá s Kwh/ciklus	Legma gasab b hőmé rsékle t (C)	Maradék nedvesség %/centrifugálá si sebesség rpm-ben
20C	5	20	1:01	0.195	51	20	65%/1000
Cotton 60C	10	60	3:44	1.972	85	60	53%/1500
Mix	10	40	1:20	0.871	85	40	70%/800
Quick 15	2	Hideg	0.15	0.030	31	Hideg	75%/800
Bed Linen	10	4	1:48	0.920	85	40	65%/1000
ECO 40-60	10	-	3:59	1.015	70.6	38	53%/1450
	5	-	3:00	0.635	55.3	33	53%/1450
	2.5	-	3:00	0.286	38.8	22	53%/1450

- A fenti adatok tájékoztató jellegűek, és az eltérő tényleges felhasználás miatt változhatnak körülmények.
- Az ECO 40-60 programtól eltérő programokhoz megadott szelepek tájékoztató jellegűek csak.
- Az EN 60456:2016/prA2019 és (EU)2019/2014, (EU)2019/2023 szabvány tekintetében, Az EU energiahatékonysági osztálya: B  
Energiaeszt program: ECO 40-60.  
Egyéb az alapértelmezett.  
Félterhelés 10,0 kg-os géphez: 5,0 kg./ Félterhelés 9,0 kg-os géphez: 4,5 kg.  
Negyed terhelés 10,0 kg-os géphez: 2,5 kg/ Negyed terhelés 9,0 kg-os géphez: 2,5 kg



### Forgási sebesség

Szükség esetén a centrifugálási sebesség a Speed gomb megnyomásával állítható a következő lépésekben: 0-400-600-800-1000-1200-1400



### Időzítés

A mosógép beindítási időpontjának beállítása:

1. Válasszon ki egy programot
2. Nyomja le a Delay (Időzítés) gombot az indítás késleltetési idejének beállítása érdekében (Az időzítés tartama 0-24H közötti tartományban állítható.)
3. Nyomja le a [Start/Pause] gombot az indítás időzítési funkció aktiválásához.



Program kiválasztása



Időtartam beállítása



Program elindítása

Az indítás időzítési funkció aktiválásának visszavonása:

Tartsa lenyomva a [Delay] gombot egészen addig, amíg a kijelzőn a 0H üzenet jelenik meg. Ezt még a program elkezdése előtt le kell nyomni. Amennyiben a program már elindult, nyomja le az [On/Off] gombot a program újbóli beállítása céljából.



### Pre Wash (Előmosás)

Ez a program teszi lehetővé a főmosási program előtt a ruhák előmosását. Amikor ezt a funkciót választja, indítás előtt szükséges, hogy a rekesz I fiókjába is tegyen mosószert



### Extra Rinse (További áztatás)

Ennek a funkciónak a kiválasztása a ruhák extra áztatását teszi lehetővé.



### Soil Level

A mosási idő növekszik vagy csökken, miután kiválasztotta.



### Speed Wash (Gyorsmosás)

A funkció csökkentheti a mosási időt.



### My Cycle (Az én ciklusom)

A gyakran használt program tárolásához.

A program kiválasztása és az opciók beállítása után nyomja meg a [Centrifugálás] gombot 3 másodpercig. a mosás megkezdése előtt. Az alapértelmezett beállítás a Cotton.



### SpaCare

A SpaCare funkciót a „Cotton”, „Mix”, „Bed Linen” és a „Baby Care” opciókkal választhatja ki.

A SpaCare funkció használatakor az ügyfelek láthatják a dobban lévő gőzt.



### Night Wash (Éjszakai mosás)

Ha a kiválasztott centrifugálási sebesség meghaladja a 800 ford./perc értéket, váltson 800 ford./percre, és közben törölje a gomb hangját.



### Hőmérséklet beállítása

A hőmérséklet értékének beállítására szolgáló gomb (20°C, 30°C, 40°C, 60°C, 90°C).



### Gyerekszár

A gyermekek hibás működésének elkerülése érdekében.



Nyomja meg egyszerre a [Spin] és a [Function] gombot 3 másodpercig, amíg a berregő sípol. A gyerekszár jelzőfénye bekapcsol.

### VIGYÁZAT

Ha a gyermekzár be van kapcsolva, a kijelzőn felváltva megjelenik a „CL” és a hátralévő idő. Bármely másik gomb megnyomására a Gyerekszár jelzőfény 3 másodpercig villogni kezd. Amikor a program véget ér, a „CL” és „END” felirat váltakozva jelenik meg a kijelzőn. A Gyerekszár kikapcsolja az összes gomb funkcióját, kivéve a Gyerekszár gombot! Csak a két [Temp.] és [Function] gomb egyidejű megnyomásával kapcsolható ki a gyermekzár! Kérjük, kapcsolja ki a Gyerekszárát, mielőtt új programot választ!



### A hangjelző némítása

Válassza ki a programot.

Nyomja meg a [Spin] gombot 3 másodpercig, a hangjelzés elnémul.

A csengő funkció aktiválásához nyomja meg ismét a gombot 3 másodpercig. A beállítás a következő visszaállításig megmarad



### VIGYÁZAT

- A hangjelzés funkció elnémítása után a hangok többé nem kapcsolódnak be.



### Ruhák hozzáadása a mosási program futása során

Ez a művelet elvégezhető a mosási folyamat során is. A vízszint magasabb állása, magasabb hőmérséklet, illetve a forgódob forgása esetén az ajtó biztonsági okokból kifolyólag zárva marad, így ezekben a helyzetekben a további ruhák hozzáadása nem lehetséges.

Nyomja le és tartsa lenyomva a [Start/Pause] gombot 3 másodperc erejéig, ezután válik lehetségessé a ruháknaSk a mosás közbeni hozzáadása. Kérjük, kövesse az alábbi lépéseket:

1. Várja meg, amíg a forgódob leáll.
2. Az ajtózár kioldása megtörténik.
3. A ruhák behelyezése után zárja be az ajtót, majd újra nyomja le a [Start/Pause] gombot.

## X. TISZTÍTÁS ÉS KARBANTARTÁS

### Tisztítás és karbantartás

A karbantartási munkálatok megkezdése előtt kérjük, hogy kapcsolja le a készüléket a villamos-energia hálózatról, valamint zárja el a vízcsapot is.

#### A mosógép tartályának tisztítása

A tartály belsejében fémdarabok által hátrahagyott rozsdamaradékokat azonnali hatállyal klórmentes mosószerrel kell eltávolítani. Ne használjon fémszivacsokat.

A tartály tisztítása közben ne helyezzen ruhákat annak belsejébe.

#### Az ajtó tömítéseinek és ablakának tisztítása

Az ajtó tömítéseiről és ablakáról minden mosás után le kell tisztítani a foltokat és szöszlerakódásokat. A szöszök összecsomósodása vízszivárgásokhoz vezethet. Minden mosás után távolítsa el a tömítésben felgyűlt tárgyakat, pénzérméket, gombokat

#### A víz befolyó szűrőjének tisztítása

A befolyó szűrő tisztítása akkor szükséges, ha a mosáshoz szükséges vízmennyiség csökken.

A szűrő tisztítása a csappal való csatlakozásnál:

1. Zárja el a csapot.
2. Csatlakoztassa le a csapról a befolyócsövet.
3. Tisztítsa ki a szűrőt.
4. Csatlakoztassa vissza a csapra a befolyócsövet.

A szűrő tisztítása a mosógéppel való csatlakozásnál:

1. Csavarozza le a mosógép hátsó részén található befolyócsövet.
2. Emelje ki a szűrőt egy hosszú csőrű fogó segítségével és takarítás után helyezze vissza.
3. A szűrő tisztításához használjon kefét.
4. Csatlakoztassa vissza a befolyócsövet

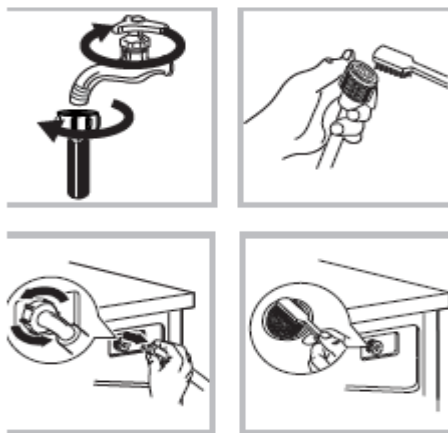

### A kifolyó pumpához tartozó szűrő tisztítása

1. Vigyázzon a forró vízzel!
2. Az áramütés elkerülése érdekében a szűrő tisztítása közben húzza ki a készülék dugaszát a villamosenergia hálózatról.
3. A kifolyó pumpájának szűrője mosás közben visszatarthatja az apró tárgyakat.

A mosógép megfelelő működésének érdekében időszakosan tisztítsa ki a szűrőt

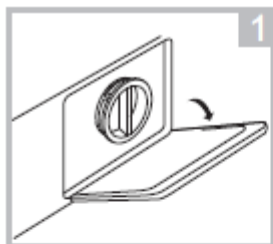

Nyissa le az alsó részen található védőlemez

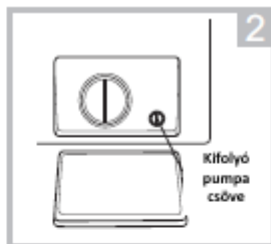

Fordítsa el 90 fokkal, húzza ki a csövet, majd húzza ki annak dugóját



A víz kifolyása után helyezze vissza a csövet

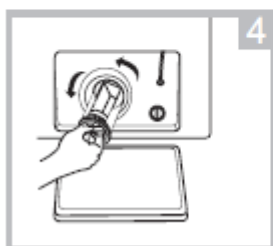

Oramutató járásával ellentétes irányba csavarva távolítsa el a szűrőt



Távolítsa el belőle az idegen testeket

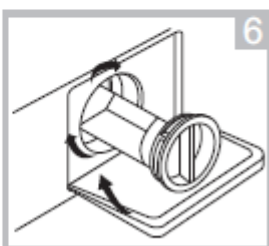

Csavarja vissza a szűrőt és zárja vissza az alsó részen található védőlemez

A választott mosási program függvényében előfordulhat, hogy a kifolyó pumpájában forró víz gyűljön fel. A mosás tartama alatt ne távolítsa el a pumpa védőlemezét és várjon addig, ameddig a mosási program véget ér és a víz lefolyása befejeződik. A védőlemez visszaszerelésekor bizonyosodjon meg arról, hogy annak rögzítése megfelelően történt.

## XI. HIBAEHÁRÍTÁS

### Hibaelhárítás

Amennyiben a készülék nem indul el, vagy megáll működés közben, először próbálkozzon a meghibásodásnak az alábbi táblázatban foglaltak szerinti azonosításával és elhárításával, és amennyiben nem jár sikerrel, vegye igénybe egy szerviz szolgáltatásait.

Leírás	Okok	Elhárítási javaslatok
A mosógép nem indul el	Az ajtó nincs jól bezárva	Az ajtó bezárása után indítsa be újra a mosógépet Vigyázzon, hogy a ruhák ne akadályozzák az ajtó zárását
Az ajtót nem lehet kinyitni	A készülék biztonsági rendszere aktiválódott	Az áramellátást szakítsa meg, majd kapcsolja vissza
Vízszivárgások	A be- vagy kifolyó cső csatlakoztatásai nincsenek megfelelően megszorítva	Ellenőrizze és szorítsa meg a csatlakoztatásokat. A kifolyó csövét tisztítsa ki.
A rekeszben mosószer maradványok vannak	A mosószer nedves lett vagy megcsomósodott	A mosószeres rekeszt tisztítsa ki, majd törölje ki
A fényjelzések vagy a kijelző nem működnek	Villamosenergia ellátási problémák	Ellenőrizze a berendezés áramellátását és a dugasz csatlakozását
Szokatlan zajok		Bizonyosodjon meg róla, hogy a szállítócsavarokat eltávolították, valamint arról, hogy a mosógép tartófelülete sima, szilárd és a gép stabilan áll rajta

Leírás	Okok	Elhárítási javaslatok
E30	Az ajtó nincs jól bezárva	Az ajtó bezárása után indítsa újra a mosógépet. Vigyázzon, hogy a ruhák ne akadályozzák az ajtó zárását
E10	Mosás közben felmerülő vízellátási problémák	Bizonyosodjon meg róla, hogy a befolyó víz nyomása nem túl alacsony Egyenesítse ki a víz befolyó csövét Bizonyosodjon meg róla, hogy a szűrő nem dugult el
E21	A víz leeresztése a készülékből nem megfelelő	Bizonyosodjon meg róla, hogy a kifolyó szűrője nem dugult el
E12	Túl nagy a víz mennyisége	Indítsa újra a készüléket
EXX	Egyebek	Végezze el az összes szükséges ellenőrzést, majd forduljon egy szervizhez.

Az ellenőrzés elvégzése után indítsa el a mosógépet. Amennyiben a probléma ismételt jelentkezik vagy a kijelzőn más hibajelzések is megjelennek, forduljon egy szervizhez.

**A hulladékok környezetfelelős eltávolítása**

Segíthet a környezet védelmében!

Kérjük, tartsa be a helyi rendelkezéseket: a nem működő elektromos berendezéseket a használt elektromos hulladékokat gyűjtő központba szolgáltatassa be.



**A HEINNER** a **Network One Distribution SRL(KFT)** társaság által bejegyzett védjegy. A többi márkajelzés és a termékek megnevezése kereskedelmi vagy az illető birtoklók által bejegyzett márkanevek.

A műszaki leírások egyik része sem reprodukálható semmilyen formában és semmilyen módon, és nem használható fel fordításra, átváltoztatásra vagy alkalmazásra a NETWORK ONE DISTRIBUTION társaság előzetes beleegyezése nélkül.

Copyright © 2013 Network One Distribution. Minden jog fenntartva.

[www.heinner.com](http://www.heinner.com), <http://www.nod.ro>  
<http://www.heinner.com>, <http://www.nod.ro>



A terméket az Európai Közösség előírásainak és jogszabályainak megfelelően tervezték és gyártották.

Importőr: **Network One Distribution**

Marcel Iancu utca, 3-5 szám, Bukarest (București), Románia

Tel: +40 21 211 18 56, [www.heinner.ro](http://www.heinner.ro), [www.heinner.com](http://www.heinner.com)



