

AUTOMATIC WASHING MACHINE

Model:
HWM-TL8013IVA++



- Automatic washing machine
 - Loading capacity: 8 kg
 - Energy class: A

HEINNER

1. INTRODUCTION

Please read the instructions carefully and keep the manual for future information.

This manual is designed to give all necessary instructions concerning installation, use and maintenance of the unit. In order to operate the unit correctly and safely, please read this instruction manual carefully before installation and use.

2. CONTENT OF YOUR PACKAGE

- ➔ **Automatic washing machine**
- ➔ **User manual**
- ➔ **Warranty card**

3. CONTENT OF YOUR PACKAGE

GENERAL

Please read the following safety information thoroughly and follow it strictly to minimize the risk of fire or explosion, electric shock and to prevent property damage, personal injury or loss of life. Failing to follow these instructions shall void any warranty.

- The appliance can be used by children aged from 8 years and above and persons with reduced physical, sensory, or mental capabilities or lack of experience and knowledge if they have been given supervision or instruction concerning use of the appliance in a safe way and understand the hazards involved. Children shall not play with the appliance. Cleaning and user maintenance shall not be done by children without supervision.
- Children should be supervised so that they do not play with the appliance.
- Children 3 years and under shall be kept away from the appliance or continuously supervised.
- Animals and children may climb into the machine. Check the machine before every operation.
- Do not climb or sit on the appliance
- All washing and additional substances are to be kept in a safe place out of the reach of children.
- Do not install the machine on a carpet floor. The obstruction of the openings by a carpet can damage the machine.
- Keep the appliance clear from heating sources and direct sunlight to avoid plastic and rubber parts corroding.
- Do not use the appliance in humid environments or rooms containing explosive or caustic gas. In case of water leakage or water splashes let the appliance dry in the open air.
- The appliance must not be installed behind a lockable door, a sliding door or a door with a hinge on the opposite side to that of the washing machine.

- Do not operate the machine in rooms with a temperature of below 5°C. This can cause damage to parts of it. If it is unavoidable, make sure to drain the water completely from the appliance after every use to avoid damages caused by frost.
- Never use flammable sprays or substances in the immediate proximity of the appliance.
- If the supply cord is damaged, it must be replaced by the manufacturer, its service agent or similarly qualified persons in order to avoid a hazard.
- If the machine is damaged, it must not be operated unless repaired by the manufacturer, its service agent or similarly qualified persons. Risk of electric shock!

INSTALATION

- Remove all packaging material and transport bolts before using the appliance. Otherwise, serious damage may result.
- This appliance is equipped with a single inlet valve and can be connected to the cold-water supply only.
- Mains plug must be accessible after installation.
- Before washing clothes for the first time, the product shall be operated once throughout all the procedures without any clothes inside.
- Before using the washing machine, the product shall be calibrated.
- Do not put any excessively heavy objects on the appliance, like water containers or heating devices.
- The new hose-sets supplied with the appliance are to be used and that old hose-sets should not be reused.
- Max. Inlet water pressure 1 MPa. Min. inlet water pressure 0.1MPa.

ELECTRICAL CONNECTION

- Make sure the supply cable is not trapped by the machine, it can get damaged.
- Connect the product to a grounded outlet protected by a fuse complying with the values in the “Technical specifications” table. The grounding installation has to be done by a qualified electrician. Ensure that the machine is installed in accordance with the local regulations.

WARNING!

- Don't use multiple plugs or extension cords.
- The appliance must not have an external switching device such as a timer or connected to a circuit that is regularly switched on and off.
- Do not pull the plug out of the mains outlet if there is flammable gas around.
- Never pull out the power plug with wet hands.
- Always pull at the plug, not at the cable.
- Always unplug the appliance if it is not being used.

WATER CONNECTIONS

- Check the connections of the water inlet tubes, the water taps and the outlet hose for possible problems due to changes of water pressure. If the connections loosen or leak close the water tap and get it repaired. Do not use the appliance before the pipes and hoses are installed properly by qualified people.
- Glass door may become very hot during the operation. Keep children and pets far away from the machine while it is operating.

- The water inlet and outlet hoses have to be safely installed and remain undamaged. Otherwise, water leakage can occur.
- Do not remove the drain pump filter while there is still water in the appliance. Big quantities of water can leak out, and there is a risk of scalding due to hot water.

OPERATION AND MAINTENANCE

- Never use any flammable, explosive or toxic solvents. Do not use gasoline and alcohol etc. as detergents. Only select detergents that are suitable for machine washing.
- Make sure that all pockets are emptied. Sharp and rigid items such as coins, brooches, nails, screws, stones etc. may cause serious damage to this machine.
- Remove all objects from pockets such as lighters and matches before using the appliance.
- Thoroughly rinse items that have been washed by hand.
- Items that have been soiled with substances such as cooking oil, acetone, alcohol, petrol, kerosene, spot removers, turpentine, wax and wax removers should be washed in heat with an extra amount of detergent before being dried in the appliance.
- Items containing foam rubber (latex foam), shower caps, waterproof textiles, rubber backed articles and clothes or pillows fitted with foam rubber pads should not be dried in the machine
- Fabric softeners or similar products should be used as recommended in their instructions.
- Never try to open the door forcefully. The door will unlock shortly after the end of a cycle.
- Please do not close the door with excessive force. If it is found difficult to close the door, please check if the clothes are properly inserted and distributed.
- Always unplug the appliance and close the water tap before cleaning and maintenance and after each use.
- Never pour water over the appliance for cleaning purposes. Risk of electric shock!
- Repairs shall only be carried out by the manufacturer, its service agent or similarly qualified persons in order to avoid a hazard. The producer will not be responsible for damage caused by the intervention of non-authorized persons.

TRANSPORT

- Before Transport:
 - Bolts shall be reinstalled to the machine by a specialized person
 - Accumulated water shall be drained out of the machine.
- This appliance is heavy.
- Transport with care.
- Never hold any protruding part of the machine when lifting.
- The machine door cannot be used as a handle.

INTENDED USE

The product is intended only for home use and for textiles in household amounts suitable for machine washing and drying. This appliance is for indoor use only and not intended for built in use. Only use according to these instructions. The appliance is not intended for commercial use. Any other use is considered improper use. The producer is not responsible for any damage or injuries that may result of it.

• This appliance is intended to be used in household and similar applications such as:

- Staff kitchen areas in shops, offices and other working environments.
- Farm houses.
- By clients in hotels, motels and other residential type environments.
- Bed and breakfast type environments.
- Areas for communal use in blocks of flats or in laundrettes.

4. PRODUCT DESCRIPTION

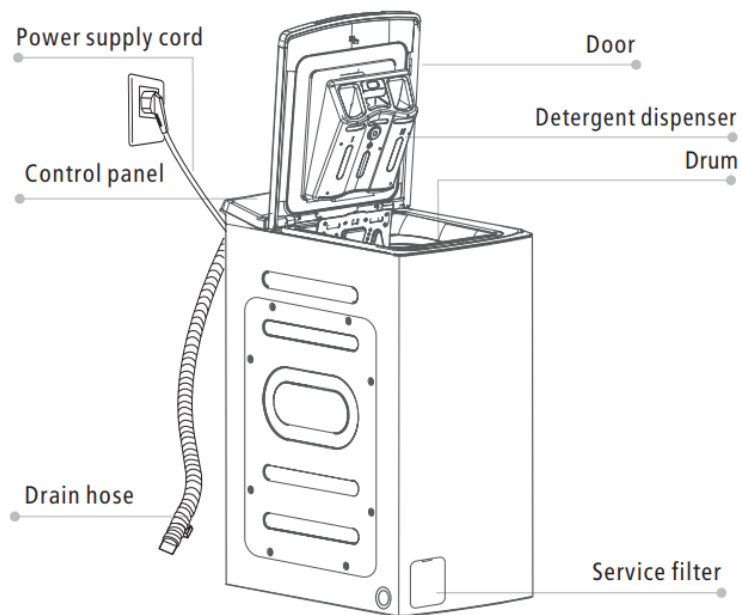

Accessories

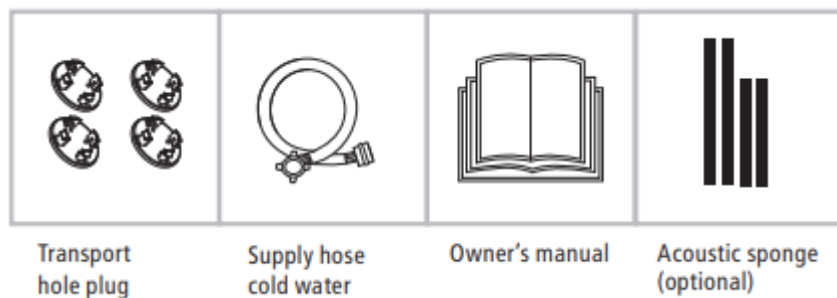

5. CONTROL PANEL

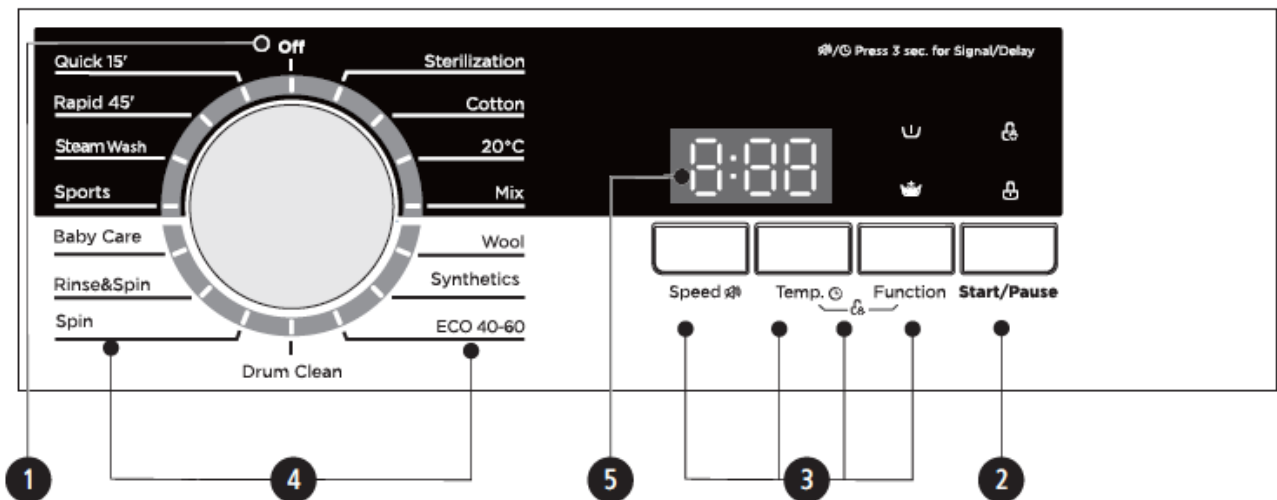

1. Power
Product is on/off.
2. Start/Pause
Press the button to start or pause the washing cycle.
3. Option
This allows you to select an additional function and will light when selected.
4. Programs
Available according to the laundry type.
5. Display
The display shows the settings, estimated cycle remaining, options, and status messages for your washer. The display will remain on through the cycle.

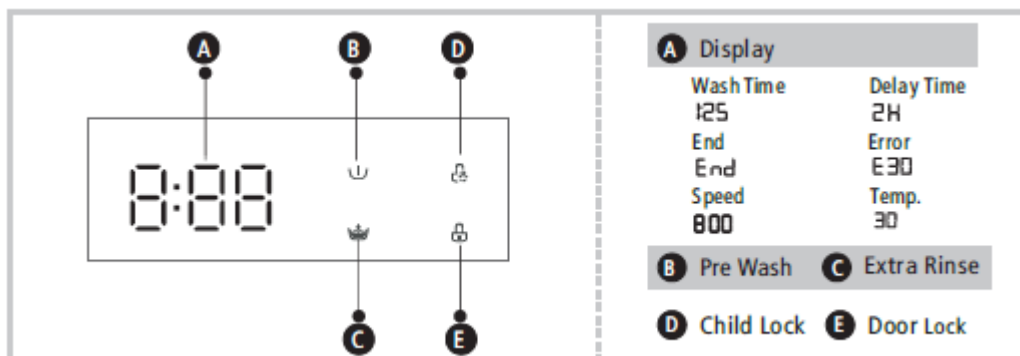

6. INSTALLATION

Installation area

- Stability is important to prevent the product from wandering!
- Make sure that the product should not stand on the power cord.
- Before installing the machine, the location characterized as follows shall be selected:
 1. Rigid, dry, and level surface
 2. Avoid direct sunlight
 3. Sufficient ventilation
 4. Room temperature is above 5°C
 5. Keep far away from the heat resources such as coal or gas.

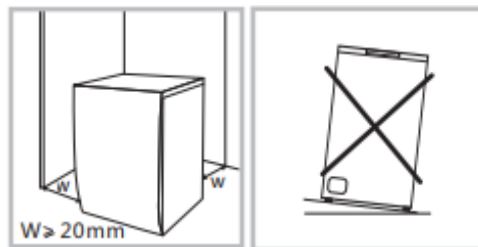

Unpacking the washing machine

- Packaging material (e.g. Films, Styrofoam) can be dangerous for children.
 - There is a risk of suffocation!
 - Keep all packaging well away from children.
1. Remove the cardboard box and styrofoam packing.
 2. Lift the washing machine and remove the base packing. Make sure the small triangle foam is removed with the bottom one together. If not, lay the unit down with side surface, then remove the small foam from the unit bottom manually.
 3. Remove the tape securing the power supply cord and drain hose.
 4. Remove the inlet hose from the drum. Make sure the small triangle.

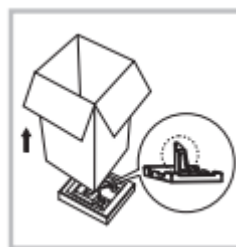

Remove transport bolts.

- You must remove the transport bolts from the backside before using the product.
- You'll need the transport belts again if you move the, so make sure keep them in a safe place.

Please take the following steps to remove the bolts:

1. Loosen 4 bolts with spanner and then remove them.
2. Stop the holes with transport hole plugs.
3. Keep the transport bolts properly for future use.

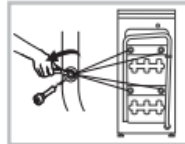

Loosen the 4 transport bolts with a spanner.



Remove the bolts including the rubber parts and keep them for future use.



Close the holes using the cover caps.

Levelling the washing machine

- The lock nuts on all four feet must be screwed tightly against the housing
1. Loosen the lock nut.
 2. Turn your foot until it reaches the floor.
 3. Adjust the legs and lock the nuts with a spanner. Make sure the machine is level and steady.



Connect the water supply hose!

To prevent leakage or water damage, follow the instructions.

- Do not kink, crush or modify water inlet hose.
- Connect manually, do not use tools. Check if the connections are tight.



Connect the water supply hose to the water inlet valve and a water tap with cold water as indicated.



Drain Hose

- Position drain hose properly, otherwise damage might result of water leakage.
- Do not kink or protract the drain hose

There are two ways to place the end of drain hose:

1. Put it into the water trough.

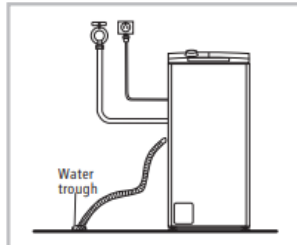

2. Connect it to the branch drain pipe of the trough.

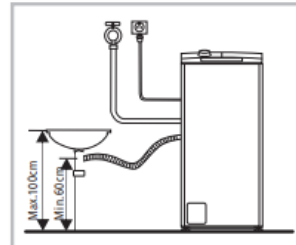

- If the machine has drain hose support, please install it like the following.

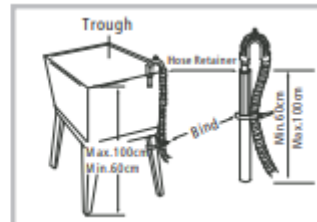
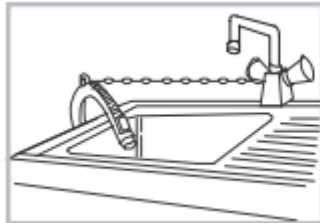

- When installing drain hose, fix it properly with a rope
- If the drain hose is too long, do not force it into washing machine as it will cause abnormal noises.

7. OPERATION

- Before washing, please make sure the washing machine is installed properly.
- Your appliance was thoroughly checked before it left the factory. To remove any residual water and to neutralize potential odors, it's recommended to clean your appliance before first use. For this reason, start the Drum Clean program at without laundry and detergent.

Before washing.

- Detergent needs to be added in "case I "after selecting pre-washing for machines with this function.
- Make sure that the drum flaps are properly locked.

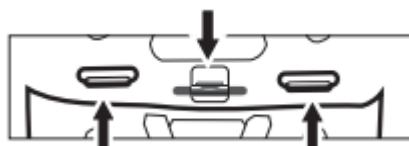

- All metal hooks must be properly hooked inside the rear door flap.
- Check the roller before each laundry, it must roll smoothly.

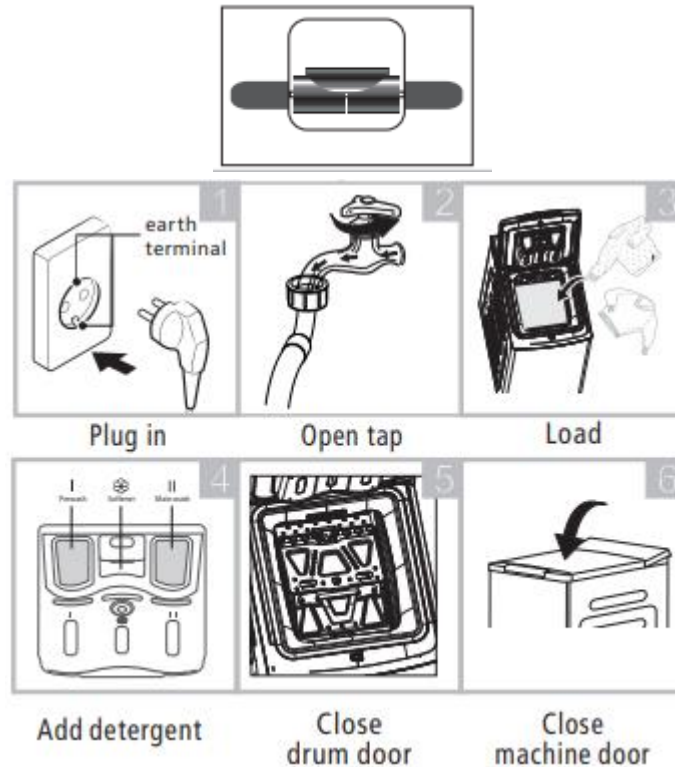

Washing and after washing



“End” on display.

Before Each Washing

- The ambient temperature of the washing machine should be 5-40°C. If used under 0°C, the inlet valve and draining system may be damaged. If the machine is installed under freezing conditions, it should be transferred to normal ambient temperature to ensure the water supply hose and drain hose can unfreeze before use.
- Please check your laundry care labels and the detergent use instructions before washing. Use non-foaming or less-foaming detergent suitable for machine washing properly.

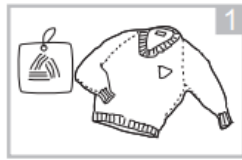

Check the care label



Sort laundry according to color and textile type



Take all items out of the pockets



Tie together long textile strips and belts, close zips and button



Put small items into a laundry bag



Turn easy-pilling and long-pile fabric inside out

- Do not wash or dry articles that have been cleaned in, washed in, soaked in, or dabbed with combustible or explosive substances like wax, oil, paint, gasoline, alcohol, kerosene, and other flammable materials.
- Washing single clothes items may easily create big eccentricity and cause alarm due to unbalance. Therefore, it is suggested to add one or two more laundry items to the wash so that spin can be done smoothly.

Detergent Dispenser

- I Pre wash detergent
- II Main wash detergent
- ☼ Softener

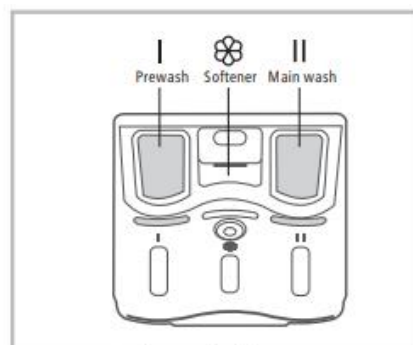

Pull out the dispenser

- Detergent only needs to be added in "case I" after selecting pre-washing for machines with this function.
- Do not exceed the "MAX" level mark when filling in detergent, additives or softener.

Programme	I	II	☼	Programme	I	II	☼
Sterilization		●	○	Spin			
Cotton	○	●	○	Rinse&Spin			○
20°C	○	●	○	Baby Care	○	●	○
Mix	○	●	○	Sports	○	●	○
Wool		●	○	Steam Wash	○	●	○
Synthetics	○	●	○	Rapid 45'		●	○
ECO 40-60		●	○	Quick 15'		●	○
Drum Clean							

- Means must
- Means optional

Detergent Recommendation

Recommended washing detergent	Wash cycles	Washing temp	Type of laundry and textile
Heavy-duty detergent with bleaching agents and optical brighteners	Cotton, Mix	20/40/60	White laundry made from boil-proof cotton or linen
Color detergent without bleaching agent and optical brighteners	Cotton, Mix	Cold/20/40	Colored laundry made from cotton or linen
Color or mild detergent without optical brighteners	Synthetics	Cold/20/40	Colored laundry made from easy care fibres or synthetic materials
Mild washing detergent	Synthetics	20/40	Delicate textiles, silk, viscose
Special wool detergent	Wool	20/40	Wool

- Agglomerating or ropy detergent or additive can be diluted in some water before pouring it into the detergent dispenser, to avoid its inlet getting blocked and thus cause a water overflow.
- Please choose the suitable type of detergent to get a maximum of washing performance and a minimum of water and energy consumption
- To achieve the best cleaning result a proper detergent dosing is important.
- Use a reduced detergent amount if the drum is not filled completely.
- Always adjust the amount of detergent to the water hardness, if your tap water is soft, use less detergent.
- Dose according to how dirty your laundry is, less dirty clothes require less detergent.
- Highly concentrated (compact detergent) requires particularly accurate dosing.















Following symptoms are a sign of detergent overdosing:









- heavy foam formation
- poor washing and rinsing result











Following symptoms are a sign of detergent underdosing:

- laundry turns grey
- built-up of limescale deposits on the drum, the heating element and/or the laundry

Cycle	Nominal capacity in kg	Temperature setting	Cycle duration in hours and minutes	Energy consumption in kWh/operalling cycle	Water consumption in liter/operalling cycle	Highest temperature °C ¹⁾	Residual moisture in % /spin speed ²⁾
Quick 15'	2.0	cold	0:15	0.026	34	cold	70%/800
20°C	4.0	20	1:01	0.183	47	20	70%/800
Cotton	8.0	60	2:45	1.394	71	60	53%/1300
Synthetics	4.0	40	2:20	0.625	44	40	70%/800
Mix	8.0	40	1:20	0.754	71	40	70%/800
ECO 40-60 ³⁾	8.0	-	3:38	0.739	57	38	53.9%/1250
	4.0	-	2:48	0.456	47	32	53.9%/1250
	2.0	-	2:48	0.196	38	23	53.9%/1250

Cotton	
Washing temperature	40°C
Maximum wash laundry amount	8kg
Spin speed selection(rpm)	1000
Additional functions	  
Default program duration (Min)	02:40
Laundry type / descriptions	Hard-wearing textiles, heat-resistant textiles made of cotton or linen.
Synthetic	
Washing temperature	40°C
Maximum wash laundry amount	4 kg
Spin speed selection(rpm)	1000
Additional functions	  
Default program duration (Min)	02:20
Laundry type / descriptions	Wash synthetic articles, for example: shirts, coats, blending. While washing the knitting textiles, detergent quantity shall be reduced due to its loose string construction and easily forming bubbles
Baby Care	
Washing temperature	60°C
Maximum wash laundry amount	4 kg
Spin speed selection(rpm)	1000
Additional functions	  
Default program duration (Min)	02:01
Laundry type / descriptions	Washing the baby's clothes, it can make the baby's wear cleaner. and make the rinse performance better to protect the baby skin.
Rapid 45'	
Washing temperature	40°C
Maximum wash laundry amount	2 kg
Spin speed selection(rpm)	1000
Additional functions	 
Default program duration (Min)	00:45
Laundry type / descriptions	Washing few and not very dirty clothes quickly.
Mix	
Washing temperature	40°C
Maximum wash laundry amount	8 kg
Spin speed selection(rpm)	1000
Additional functions	  
Default program duration (Min)	01:20
Laundry type / descriptions	Mixed load consisting of textiles made of cotton and synthetics.

20°C	
Washing temperature	20°C
Maximum wash laundry amount	4 kg
Spin speed selection(rpm)	1000
Additional functions	  
Default program duration (Min)	01:01
Laundry type / descriptions	20°C defaults, can choose cold water
Sterilization	
Washing temperature	70°C
Maximum wash laundry amount	4 kg
Spin speed selection(rpm)	1000
Additional functions	 
Default program duration (Min)	02:27
Laundry type / descriptions	Consistent 70°C washing ensures sterilization effects. Loading weight lower than 5kg is suggested.
Quick 15'	
Washing temperature	Cold
Maximum wash laundry amount	2 kg
Spin speed selection(rpm)	800
Additional functions	
Default program duration (Min)	00:15
Laundry type / descriptions	Extra short programme approx., suitable for lightly soiled washing as a small amount of laundry
Wool	
Washing temperature	40°C
Maximum wash laundry amount	2 kg
Spin speed selection(rpm)	800
Additional functions	 
Default program duration (Min)	01:07
Laundry type / descriptions	Hand or machine-washable wool or rich wool textiles. Especially gentle wash programme to prevent shrinkage, longer programme pauses (textiles rest in wash liquor)
Spin Only	
Washing temperature	--
Maximum wash laundry amount	8 kg
Spin speed selection(rpm)	1000
Additional functions	
Default program duration (Min)	00:12
Laundry type / descriptions	Extra spin with selectable spin speed.

Rinse & Spin	
Washing temperature	--
Maximum wash laundry amount	8 kg
Spin speed selection(rpm)	1000
Additional functions	 
Default program duration (Min)	00:20
Laundry type / descriptions	Extra rinse with spin.
ECO 40-60	
Washing temperature	--
Maximum wash laundry amount	8 kg
Spin speed selection(rpm)	1300
Additional functions	
Default program duration (Min)	03:38
Laundry type / descriptions	Washing brightly coloured clothes, it can protect the colours better. Default 40°C, not selectable, suitable for laundry washing at about 40°C-60°C
Drum Clean	
Washing temperature	90°C
Maximum wash laundry amount	-
Spin speed selection(rpm)	1000
Additional functions	
Default program duration (Min)	01:18
Laundry type / descriptions	Specially set in this machine to clean the drum and tube. It applies 90 °C high temperature sterilization to make the clothes washing greener. When this programme is performed, the clothes or other washing cannot be added. When proper amount of chlorine bleaching agent is put in, the barrel cleaning effect will be better. The customer can use this programme regularly according to the need.
Steam-Wash	
Washing temperature	40°C
Maximum wash laundry amount	2.5 kg
Spin speed selection(rpm)	800
Additional functions	  
Default program duration (Min)	01:48
Laundry type / descriptions	The Steam Wash can deeply penetrate the fiber, which effectively eliminate bacterias and germs, preventing odors and protecting health.
Sports	
Washing temperature	20°C
Maximum wash laundry amount	4 kg
Spin speed selection(rpm)	1000
Additional functions	  
Default program duration (Min)	00:45
Laundry type / descriptions	Washing the activewear



Spin Speed

When needed, the spinning speed can be adjusted pressing the Speed button in the following steps: 1300: 0-400-600-800-1000-1200-1300



Delay

Set the Delay function:

1. Select a program.
2. Press the Delay button to choose the time (the delay time is 0-24h).
3. Press [Start/Pause] to commence the delay operation



Cancel the Delay function: Press the [Delay] button until the display light is off.

It should be pressed before starting the program.

If the program already started, should switch off the program to reset it to a new one.



Pre-Wash

Extra washing function before the main washing cycle starts to increase the washing performance. Note: Detergent needs to be added to compartment I.



Extra Rinse

The laundry will undergo an extra rinse after selecting this function.



Temp.

When needed, the washing temperature can be adjusted by pressing the temperature button in the following steps: Cold - 20°C - 40°C - 60°C - 90°C.



Child Lock

This function is meant to keep children from misusing the controls.

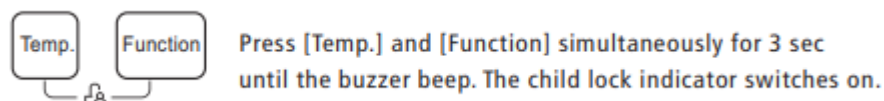

When the Child Lock is activated, the display will alternately show "CL" and the remaining time.

Pressing any other button will cause the Child Lock indicator to flash.

When the program ends, "CL" and "END" will alternate on the display.

The Child Lock deactivates the function of all buttons except the On/Off button and the Child lock button!

Only the simultaneous pressing of the two buttons [Temp.] and [Function] can deactivate the Child Lock!

Please deactivate the Child Lock before selecting a new program!

Mute the buzzer

Choose the Programme



Press the [Speed] button for 3sec.,
the buzzer is mute.

To act the buzzer function, press the button again for 3 seconds. The setting will be kept until the next reset.

CAUTION

- After Muting the buzzer function, the sounds will not be activated any more

8. MAINTENANCE

Cleaning and Care

- Before your maintenance starts, please unplug the machine and close the tap.

Cleaning The Cabinet

- Proper maintenance on the washing machine can extend its working life.
- The surface can be cleaned with diluted non-abrasive neutral detergents when necessary.
- If there is any water overflow, use the wet cloth to wipe it off immediately.
- No sharp items are allowed.
- Formic acid and its diluted solvents or equivalent are forbidden, such as solvents or chemical products, etc.

Cleaning the drum

- The rusts left inside the drum by the metal articles shall be removed immediately with chlorine-free detergents.
- Never use steel wool.
- Don't put laundry in the washing machine during the drum cleaning.

Cleaning the Inlet Filter

- Diminishing water flow is a sign that the filter needs to be cleaned.
1. Close the tap and remove the water supply hose from it.
 2. Clean the filter with a brush.
 3. Unscrew the water supply hose from the backside of the machine. Pull out the filter with long nose pliers.
 4. Use a brush to clean the filter.
 5. Reinstall the filter to the water inlet and reconnect the water supply hose.
 6. Clean the Inlet filter every 3 months to ensure the normal operation of the appliance.

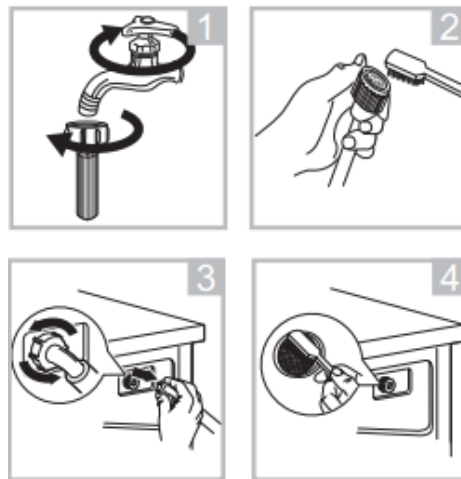

Clean The Detergent Dispenser

1. Press down the arrow location on softener cover inside the dispenser drawer.
2. Lift the clip up and take out softener cover and wash all grooves with water.
3. Restore the softener cover and push the drawer into position.

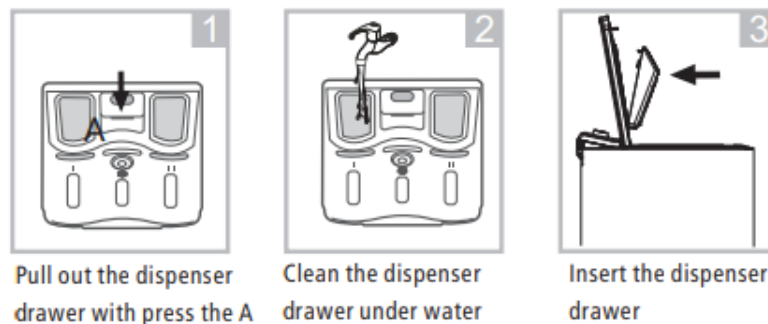

- Do not use abrasive or caustic agents to clean plastic parts.
- Clean the detergent dispenser every 3 months to ensure the normal operation of the appliance.

Cleaning the Drain Pump Filter

- Make sure that the machine has finished the washing cycle and is empty. Switch it off and unplug it before cleaning the drain pump filter.
- Be careful of hot water. Allow the water to cool down. Risk of scalding!
- Clean the filter periodically every 3 months to ensure the normal operation of the appliance.

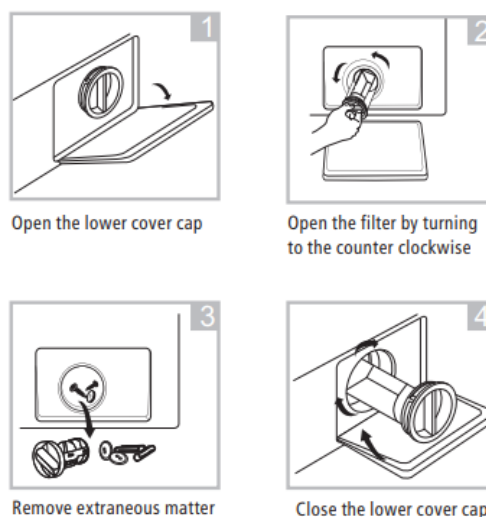

9. TROUBLESHOOTING

The start of the appliance does not work, or it stops during operation. First try to find a solution to the problem, if not, contact the service center.

Description	Reason	Solution
Washing machine cannot start up	Door is not closed properly	Restart after the door is closed Check if the clothes is stuck
Door can't be opened	Washer's safety protection design is working	Disconnect the power, restart the product
Water leakage	The connection between inlet pipe or outlet hose is not tight	Check and fasten water pipes Clean up outlet hose
Detergent residues in the box	Detergent is dampened or agglomerated	Clean and wipe the detergent box
Indicator or display does not light	Disconnect the power PC board or harness has connection problem	Check if the power is shut down and the power plug is connected correctly
Abnormal noise		Check if the fixing (bolts) has been removed. Check it's installed on a solid and level floor

Description	Possible Cause	Solution
E30	Door is not closed properly.	Close the door properly and restart
E10	Water injecting problem during wash cycle.	Check if the water pressure is high enough. Straighten the water pipe. Clean the inlet valve filter.
E21	Overtime water draining	Check the drain hose for blockage.
E12	Water overflow	Restart the appliance
EXX	Others	Restart the appliance. If problem persists, please contact the customer service.

IMPORTANT STEPS WHEN MOVING THE APPLIANCE

- Check if the door and the detergent dispenser are closed properly.
- Remove the water inlet pipe and the outlet hose from the house installations.
- Let the water drain completely from the appliance
- Important: Re-install the 4 transport bolts in the back of the appliance.
- This appliance is heavy.

Transport with care.

Never hold any protruding part of the machine when lifting.

The machine door cannot be used as a handle.

TECHNICAL DATA

The technical information is situated in the rating plate on the internal side of the appliance and on the energy label.

The QR code on the energy label supplied with the appliance provides a web link to the information related to the performance of the appliance in the EU EPREL database.

Keep the energy label for reference together with the user manual and all other documents provided with this appliance.

It is also possible to find the same information in EPREL using the link <https://eprel.ec.europa.eu> and the model name and product number that you find on the rating plate of the appliance.

To access information about your product in the EPREL portal, you can scan the codes below:



Thank you for purchasing this product. If you need support with your product, visit our website using the links below.

Get User manuals: <https://www.heinner.ro>

Get Service information: <https://www.heinner.ro>

**Environment friendly disposal**

You can help protect the environment!

Please remember to respect the local regulations: hand in the non-working electrical equipment's to an appropriate waste disposal center.



HEINNER is a registered trademark of **Network One Distribution SRL**. Other brands and product names are trademarks or registered trademarks of their respective holders.

No part of the specifications may be reproduced in any form or by any means or used to make any derivative such as translation, transformation, or adaptation without permission from NETWORK ONE DISTRIBUTION.

Copyright © 2013 Network One Distribution. All rights reserved.

www.heinner.com, <http://www.nod.ro>



This product is in conformity with norms and standards of European Community



Importer: **Network One Distribution**

Marcel Iancu Street, 3-5, Bucharest, Romania

Tel: +40 21 211 18 56, www.heinner.com , www.nod.ro

MASINA DE SPALAT AUTOMATA

Model:

HWM-TL8013IVA++



- Masina de spalat automata
- Capacitate de incarcare: 8 kg
 - Clasa energetica: A

HEINNER

1. INTRODUCERE

Înainte de a utiliza acest aparat, citiți cu atenție manualul de instrucțiuni și păstrați-l pentru consultări ulterioare.

Acest manual este conceput pentru a vă oferi toate instrucțiunile necesare referitoare la instalarea, utilizarea și întreținerea aparatului.

Pentru utilizarea corectă și în siguranță a aparatului, vă rugăm să citiți cu atenție acest manual de instrucțiuni, înainte de instalare și utilizare.

2. CONȚINUTUL PACHETULUI DUMNEAVOASTRA

- ➔ **Masina de spalat rufe automata**
- ➔ **Manual de utilizare**
- ➔ **Certificat de garantie**

3. MASURI DE SIGURANTA

GENERALE

- Când cablul de alimentare este deteriorat, acesta trebuie înlocuit de producător, de agentul service al acestuia sau de alte persoane cu calificări similare pentru a evita orice pericol.
- În cazul unei defecțiuni, mașina de spălat nu trebuie pusă în funcțiune înainte de a fi reparată de producător, de agentul service al acestuia sau de alte persoane cu calificări similare. Risc de electrocutare!
- Acest produs poate fi folosit de copii cu vârsta de cel puțin 8 ani și de persoane cu capacități fizice, senzoriale sau mentale reduse sau fără experiență și discernământ doar sub supraveghere sau dacă au primit instrucțiuni privind utilizarea acestuia în condiții de siguranță și dacă înțeleg pericolele implicate. Nu permiteți copiilor să se joace la mașina de spălat. Operațiunile de curățare și întreținere realizabile de către utilizator nu vor fi executate de copii nesupravegheați!
- Supravegheați copiii pentru a nu le permite să se joace la mașina de spălat.
- Copiii de 3 ani și mai mici nu vor fi lăsați în preajma mașinii de spălat sau vor fi permanent supravegheați.
- Există riscul ca animalele și copiii să intre în mașina de spălat. Verificați cuva înainte de fiecare utilizare!
- Nu vă urcați și nu vă așezați pe mașină!

LOCUL DE INSTALARE

- Țineți toate substanțele folosite la spălat și alte asemenea într-un loc sigur, ferit de accesul copiilor.
- Nu așezați mașina de spălat pe mocheta. Obstrucționarea orificiilor mașinii din cauza mochetei poate deteriora mașina.
- Instalați mașina de spălat la distanță de sursele de căldură și de lumina directă a soarelui pentru a evita deteriorarea componentelor din plastic și cauciuc.

- Nu folosiți mașina de spălat în spații cu umiditate mare sau în încăperi cu emisii de gaze explozive sau caustice. În caz de scurgeri sau stropi de apă, lăsați mașina să se usuce la aer liber.
- Nu instalați mașina de spălat în spatele unei uși cu sistem de blocare, a unei uși glisante sau a unei uși cu o balama pe partea opusă celei a ușii mașinii.
- Nu folosiți mașina în încăperi cu temperaturi sub 5°C pentru a nu deteriora componentele sale. Dacă acest lucru este totuși de neevitat, aveți grijă să drenați complet apa din mașină după fiecare utilizare.
- Nu folosiți niciodată pulverizatoare sau substanțe inflamabile în imediata apropiere a mașinii.

INSTALAREA

- Înainte de utilizare, îndepărtați toate ambalajele și șuruburile de fixare folosite la transport. În caz contrar, mașina poate suferi daune severe.
- Această mașină este prevăzută cu o valvă de admisie simplă și se poate conecta doar la rețeaua de apă rece.
- Ștecherul mașinii trebuie să rămână accesibil după instalare.
- Înainte de prima spălare, realizați un ciclu complet de spălare în gol (fără rufe).
- Înainte de a folosi mașina de spălat, efectuați calibrările necesare.
- Nu puneți pe mașină obiecte excesiv de grele, ca de exemplu recipiente de apă sau dispozitive de încălzit.
- Folosiți seturile noi de furtunuri furnizate odată cu mașina. Nu reutilizați seturile vechi.
- Presiunea max. de admisie a apei este de 1 MPa. Presiunea min. de admisie a apei este de 0,05 MPa.

CONEXIUNEA ELECTRICĂ

- Aveți grijă să nu prindeți cablul de alimentare sub mașină pentru a nu se deteriora.
- Conectați mașina la o priză cu siguranță și împământare, respectând valorile din tabelul de „Specificații tehnice”. Instalația cu împământare trebuie realizată de un electrician calificat. Asigurați-vă că instalarea mașinii se face în conformitate cu reglementările locale.
- Conexiunile la apă și cele electrice trebuie realizate de un tehnician calificat, cu respectarea instrucțiunilor producătorului și a reglementărilor locale privind siguranța.

Avertisment!

- Nu folosiți ștechere multiple sau prelungitoare.
- Mașina nu trebuie să aibă un dispozitiv extern de comutare, ca de exemplu un cronometru, sau nu trebuie conectată la un circuit care este frecvent oprit și pornit.
- Nu trageți ștecherul din priză dacă sunt gaze inflamabile în jur.
- Nu scoateți niciodată ștecherul din priză cu mâinile ude.
- Apucați întotdeauna de ștecher, nu de cablu.
- Deconectați mașina de la curent ori de câte ori nu este folosită.

RACORDAREA LA APĂ

- Verificați conexiunile conductelor de admisie a apei, robinetul de apă și furtunul de evacuare pentru a depista eventualele probleme cauzate de fluctuațiile de presiune a apei. Dacă aceste conexiuni sunt slăbite sau prezintă scurgeri, închideți robinetul de apă și reparați-l. Nu folosiți mașina înainte ca furtunurile și conductele să fie instalate de persoane calificate.
- Ușa mașinii de spălat se poate înfierbânta foarte tare în timpul funcționării. Nu lăsați copiii și animalele de companie în apropierea mașinii în timpul funcționării acesteia.
- Furtunurile de admisie și evacuare a apei trebuie instalate corect și păstrate intacte. În caz contrar, pot apărea scurgeri de apă.

- Nu scoateți filtrul pompei de evacuare cât timp în mașină este încă apă. În caz contrar, cantități mari de apă fierbinte se pot scurge în afară, cu risc de opărire.

MODUL DE FUNCȚIONARE ȘI ÎNTREȚINEREA

- Nu folosiți niciodată niciun fel de solvenți inflamabili, explozivi sau toxici. Nu folosiți gaz și alcool ca detergenți. Alegeți doar detergenți recomandați pentru spălare automată.
 - Aveți grijă să goliți toate buzunarele. Articolele ascuțite și dure, ca de exemplu monedele, broșele, cuietele, șuruburile, pietrele etc., pot cauza daune severe mașinii.
 - Înainte de punerea mașinii în funcțiune, scoateți din buzunare toate obiectele, de ex. brichetele și chibriturile.
 - Clătiți bine articolele care au fost spălate manual.
 - Articolele pătate cu substanțe precum: ulei de gătit, acetonă, alcool, petrol, kerosen, soluții de scos pete, terebentină, ceară și soluții de îndepărtat ceara, trebuie spălate la temperatură ridicată cu o cantitate mai mare de detergent înainte de a fi uscate în mașină.
 - Articolele care conțin cauciuc expandat (spumă de latex), căștile de duș, textilele impermeabile, articolele căptușite cu cauciuc și hainele sau pernele cu protecții din cauciuc expandat nu trebuie uscate în mașină.
 - Balsamurile de rufe sau produsele similare trebuie folosite conform recomandărilor din instrucțiunile lor.
 - Nu încercați niciodată să deschideți ușa mașinii cu forța. Ușa se va debloca automat la scurt timp după încheierea unui ciclu.
 - Nu închideți ușa cu forță excesivă. Dacă ușa este greu de închis, verificați dacă ați introdus și distribuit corect rufele în cuvă.
 - Deconectați întotdeauna mașina de la curent și închideți robinetul de apă înainte de a realiza operațiunile de curățare și întreținere și după fiecare folosire.
 - Nu turnați niciodată apă peste mașină pentru a o curăța. Risc de electrocutare!
- Lucrările de reparații se vor efectua doar de producător, de agentul service al acestuia sau de persoane cu calificări similare pentru a evita orice pericol. Producătorul nu este responsabil pentru daunele survenite în urma intervenției unor persoane neautorizate

TRANSPORTUL

- Înainte de transport:
 - O persoană specializată va reinstala șuruburile de fixare a mașinii.
 - Apa acumulată va fi drenată din mașină.
- Mașina de spălat este grea. Transportul acesteia se va face cu grijă. Nu apucați niciodată de piesele proeminente ale mașinii când o ridicați. Ușa mașinii nu poate fi folosită ca mâner.

UTILIZAREA

- Acest aparat este destinat utilizării în locuințe și alte unități similare, cum ar fi:
 - bucătăriile personalului din magazine, birouri și alte medii profesionale.
 - în gospodării și de către clienții din hoteluri, moteluri și alte medii de tip rezidențial;
 - în medii de tip pensiune cu mic dejun;
 - în zone destinate utilizării în comun din blocuri de locuințe sau în spălătorii

4. DESCRIEREA PRODUSULUI

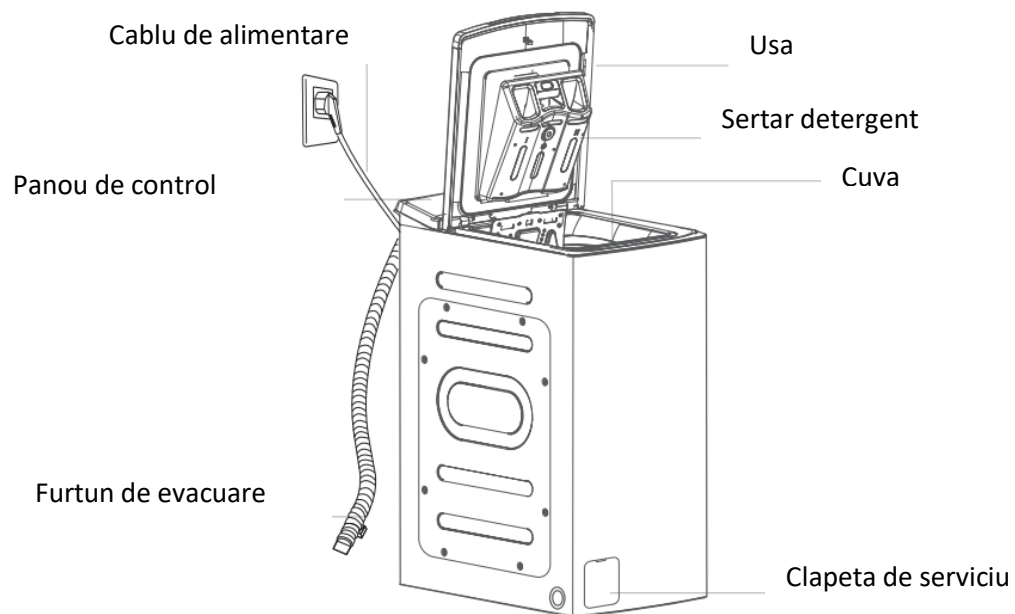

Accesorii

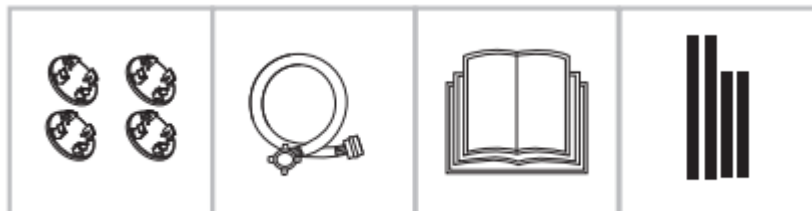

- 4 x capace de acoperire orificii
- 1 x furtun de alimentare apă rece
- 1 x Manual de utilizare

5. PANOUL DE CONTROL

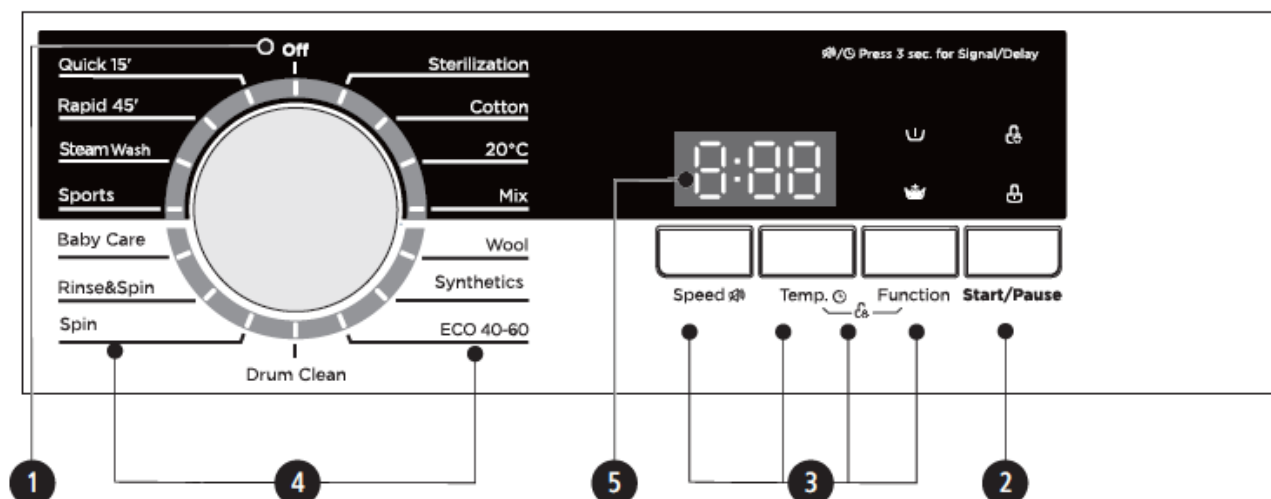

1.OFF

Mașina este on/off (pornită/oprită).

2.Start/Pauza

Apăsați acest buton pentru a porni sau întrerupe ciclul de spălare.

3.Optiuni

De aici puteți selecta o funcție suplimentară, iar la selectare ledul corespunzător se aprinde.

4.Programe

Disponibile în funcție de tipul de articole de spălat.

5.Afisaj

Afișajul arată setările, timpul estimat rămas, opțiunile și mesajele de spălare. Afișajul va rămâne activ pe toata durata ciclului de spălare.

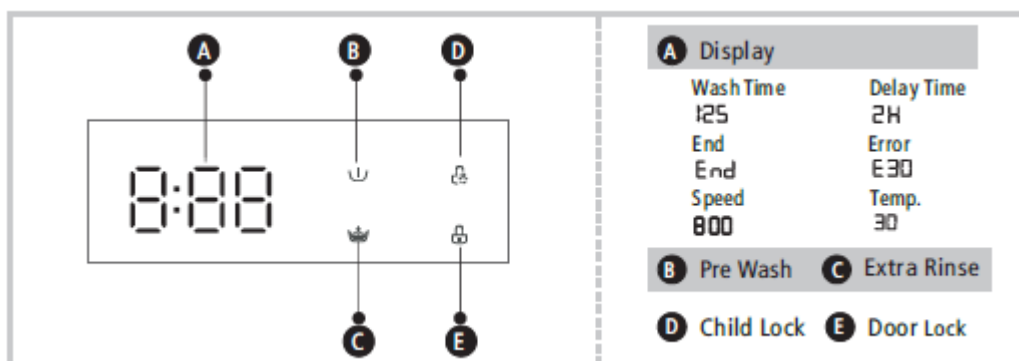

- A- Dispsay
- B- Pre-spalare
- C- Clatire suplimentara
- D- Protectie copii
- E- Blocare usa

6. INSTALAREA

Locul instalării

- Înainte de a spăla, asigurați-vă că mașina este bine instalată.
- Produsul a fost verificat înainte de a ieși din fabrică. Pentru a îndepărta orice reziduuri de apă și a neutraliza eventualele mirosuri neplăcute, este recomandat să curățați mașina înainte de prima utilizare. Pentru aceasta, rulați programul Drum Clean, fără rufe și detergent.

1. Scoateți cutia de carton și ambalajul din spumă de polistiren.
2. Ridicați mașina de spălat și scoateți ambalajul de bază. Asigurați-vă că spuma triunghiulară mică este îndepărtată împreună cu cea de jos. Dacă nu, așezați unitatea cu suprafața laterală, apoi îndepărtați manual spuma mică de pe fundul unității.
3. Scoateți banda care fixează cablul de alimentare și furtunul de evacuare.
4. Scoateți furtunul de alimentare din tambur. Asigurați-vă că triunghiul mic.

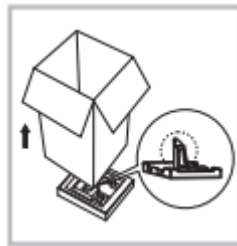

Scoaterea șuruburilor de fixare folosite la transport

- Înainte de a folosi mașina, scoateți șuruburile de fixare folosite la transport:
 1. Slăbiți cu o cheie cele 4 șuruburi de fixare folosite la transport.
 2. Scoateți șuruburile cu tot cu părțile din cauciuc și puneți-le la un loc sigur pentru a le putea folosi la nevoie.
 3. Astupați orificiile cu capacele prevăzute pentru aceasta.

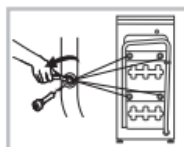

Echilibrarea mașinii de spălat

- Piulițele celor patru picioare trebuie bine strânse până la baza mașinii.

1. Slăbiți piulița.
2. Rotiți piciorul până când ajunge la nivelul solului.
3. Reglați picioarele și strângeți bine piulițele cu o cheie.
4. Asigurați-vă că mașina este dreaptă și stabilă.



Conectarea furtunului de alimentare cu apă

Pentru a preveni daunele rezultate din scurgeri sau apă, respectați instrucțiunile.

- Nu îndoiți, nu striviți și nu modificați furtunul de admisie a apei.
- Conectați furtunul de alimentare cu apă la valva de admisie a apei și un robinet de apă rece, ca în imagine.



Furtunul de scurgere

1. Puneți-l în scurgerea de apă
2. Conectați-l la conducta de evacuare a scurgerii

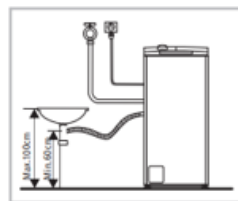
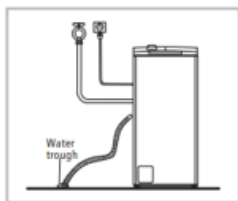

Dacă mașina are suport pentru furtun de evacuare, vă rugăm să o instalați după cum urmează.

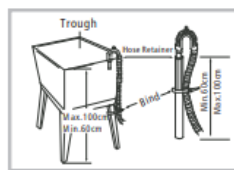
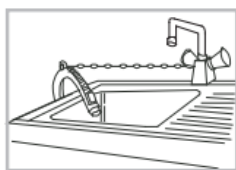

- Când instalați furtunul de scurgere, fixați-l corespunzător cu o frânghie
- Dacă furtunul de evacuare este prea lung, nu-l forțați în mașina de spălat, deoarece va provoca zgomote anormale.

7. UTILIZAREA PRODUSULUI

- Înainte de a spăla, asigurați-vă că mașina este bine instalată.
- Produsul a fost verificat înainte de a ieși din fabrică. Pentru a îndepărta orice reziduuri de apă și a neutraliza eventualele mirosuri neplăcute, este recomandat să curățați mașina înainte de prima utilizare. Pentru aceasta, rulați programul Drum Clean, fără rufe și detergent.

Înainte de spălare

- Detergentul trebuie adăugat în „I” după ce ați selectat prespălarea pentru mașinile cu această funcție.
- Asigurați-vă că, clapetele tamburului sunt blocate corect.

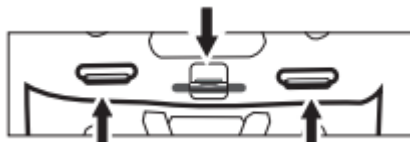

- Toate cârligele metalice trebuie să fie agățate corespunzător în interiorul clapei ușii din spate.
- Verificați rola înainte de fiecare spălătorie, aceasta trebuie să se ruleze lin.

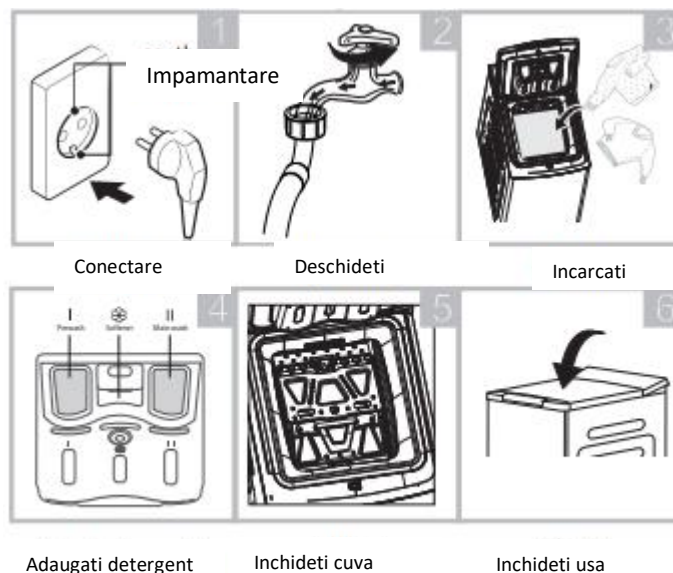
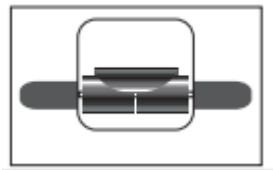

Spalarea si dupa spalare

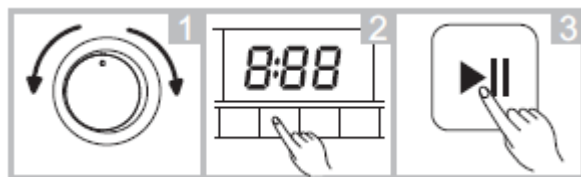

1. Selectare program.
2. Selectare funcție sau păstrare setări prestabilite
3. Apăsăți Start/Pauză pentru a porni programul.

Pe display va apărea mesajul „End”.

Înainte de fiecare spălare

- Temperatura din încăperea în care se află mașina de spălat trebuie să fie cuprinsă între 5- 40°C. În cazul folosirii acesteia la temperaturi sub 0°C, valva de admisie și sistemul de evacuare pot avea de suferit. Dacă mașina este instalată în condiții de îngheț, aceasta trebuie mutată într-un loc cu o temperatură normală pentru ca furtunul de alimentare și furtunul de evacuare să se dezghețe înainte de folosire.
- Verificați etichetele articolelor de spălat și instrucțiunile de utilizare de pe detergent înainte de spălare. Folosiți detergent ne-spumant sau ușor spumant, adecvat pentru spălare automată. Verificați eticheta de întreținere. Scoateți toate obiectele din buzunare. Sortați articolele după culoare și tipul țesăturii.

Legați șnururile și cordoanele lungi, închideți fermoarele și nasturii
Puneți articolele de mici dimensiuni într-un săculeț.

- Nu spălați în mașină articole care au fost în prealabil curățate, spălate, înmuiate sau îmbibate cu substanțe inflamabile sau explozive cum ar fi: ulei de parafină, vopsea, benzină, alcool, kerosen și alte substanțe inflamabile.
- Spălarea unui singur articol poate crea excentricitate și declanșa alarma din cauza dezechilibrului. Prin urmare, este recomandat să mai adăugați unul sau două articole de spălat pentru ca centrifugarea acestora să se facă lin.



Compartimentul pentru detergent

- I Prespălare
- II Spălare principală
- ☼ Balsam

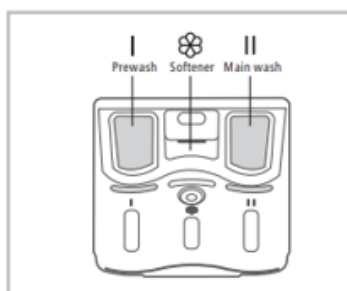

În compartimentul **I** se va adăuga detergent doar dacă ați selectat funcția de prespălare.

- Nu depășiți marcajul de nivel „MAX” atunci când completați cu detergent, aditivi sau balsam.

Program	I	II	☼	Program	I	II	☼
Sterilization		●	○	Spin			
Cotton	○	●	○	Rinse and spin			○
20 C	○	●	○	Baby care	○	●	○
Mix	○	●	○	Sports	○	●	○
Wool		●	○	Steam Wash	○	●	○
Synthetics	○	●	○	Rapid 45'		●	○
ECO 40-60		●	○	Quick 15'		●	○
Drum Clean							

○ Obligatoriu

● Optional

Recomandări privind detergentul

Detergent recomandat	Tip de articole și textile	Cicluri de spălare	Temp. de spălare
Detergent cu putere mare de curățare, cu agenți de înălbire și înălbitori optici.	Articole albe din bumbac și lenjerie de pat cu rezistență la fierbere	Cotton, Mix	20/40/60
Detergent pentru rufe colorate, fără agenți de înălbire și înălbitori optici	Articole din bumbac și lenjeriile de pat colorate	Cotton, Mix	Cold/20/40
Detergent pentru rufe colorate, fără înălbitori optici.	Articole colorate din fibre ușor de întreținut și materiale sintetice.	Synthetics	Cold/20/40
Detergent moderat de spălat	Textile delicate, mătase, viscoză.	Synthetics	20/40
Detergent special pentru lana	Lana	Lana	20/40

- Alegeți tipul adecvat de detergent pentru obține randamentul maxim de spălare și un consum minim de apă și energie.
- Pentru o curățare optimă, este important ca detergentul să fie corect dozat.

- Folosiți o cantitate redusă de detergent dacă nu ați încărcat complet cuva.
- Reglați întotdeauna cantitatea de detergent în funcție de duritatea apei; dacă apa de la robinet are o duritate mică, folosiți mai puțin detergent.
- Dozați în funcție de gradul de murdărie al articolelor de spălat; hainele mai puțin murdare necesită mai puțin detergent.
- Detergenții foarte concentrați (compacti) necesită o dozare extrem de precisă.

Următoarele simptome indică o supradozare a detergentului:















- spumare densă.
- spălare și clătire nereușite.







Următoarele simptome indică o subdozare a detergentului:







- articolele spălate devin gri.
- apar depuneri de calcar pe tambur, elementul de încălzire și/sau articolele de spălat.

Program	Capacitate nominala (Kg)	Durata ciclului	Consumul electric în KWh/ciclu de operare	Consumul de apa in L/ciclu de operare	Temperatura maxima	Umiditate reziduală în %/ viteză de centrifugare
Quick 15'	2.0	0:15	0.026	34	Rece	70%/800
20C	4.0	1:01	0.183	47	20	70%/800
Cotton	8.0	2:45	1.394	71	60	53%/1300
Synthetics	4.0	2:20	0.625	44	40	70%/800
Mix	8.0	1:20	0.754	71	40	70%/800
ECO 40-60	8.0	3:38	0.739	57	-	53.9%/1250
	4.0	2:48	0.456	47	-	53.9%/1250
	2.0	2:48	0.196	38	-	53.9%/1250

Cotton	
Temperatura de spalare	40°C
Capacitatea maxima de rufe uscate	8 kg
Selectie viteza de rotatie (rpm)	1000
Functii suplimentare	
Durata implicita program (hh:min)	02:40
Tip de rufe/Descriere	Materiale textile rezistente la uzură, textile rezistente la căldură din bumbac sau in.
Synthetic	
Temperatura de spalare	40°C
Capacitatea maxima de rufe uscate	4 kg
Selectie viteza de rotatie (rpm)	1000
Functii suplimentare	
Durata implicita program (hh:min)	02:20
Tip de rufe/Descriere	Articole sintetice, cum ar fi: bluze, sacouri, amestecate. La spălarea tricotajelor, cantitatea de detergent trebuie redusă deoarece, fiind confecționate cu ochiuri largi, acestea formează spumă ușor

Baby Care	
Temperatura de spalare	60°C
Capacitatea maxima de rufe uscate	8 kg
Selectie viteza de rotatie (rpm)	1000
Functii suplimentare	  
Durata implicita program (hh:min)	02:01
Tip de rufe/Descriere	Spălarea rufelor copiilor – hainele celor mici vor fi mai curate și mai bine clătite pentru protejarea pielii acestora
Rapid 45'	
Temperatura de spalare	40°C
Capacitatea maxima de rufe uscate	2 kg
Selectie viteza de rotatie (rpm)	1000
Functii suplimentare	 
Durata implicita program (hh:min)	00:45
Tip de rufe/Descriere	Spălarea rapidă a hainelor puține și nu foarte murdare.
Mix	
Temperatura de spalare	40°C
Capacitatea maxima de rufe uscate	8 kg
Selectie viteza de rotatie (rpm)	1000
Functii suplimentare	  
Durata implicita program (hh:min)	01:20
Tip de rufe/Descriere	Volum mixt de articole încărcate, constând din textile confecționate din bumbac și materiale sintetice
20°C	
Temperatura de spalare	20°C
Capacitatea maxima de rufe uscate	4 kg
Selectie viteza de rotatie (rpm)	1000
Functii suplimentare	  
Durata implicita program (hh:min)	01:01
Tip de rufe/Descriere	Program care foloseste apa rece, indicat pentru hainele colorate
Sterilization	
Temperatura de spalare	70°C
Capacitatea maxima de rufe uscate	4 kg
Selectie viteza de rotatie (rpm)	1000
Functii suplimentare	 
Durata implicita program (hh:min)	02:27
Tip de rufe/Descriere	Menține temperatura de spălare la peste 60 de grade pentru mai mult de 30 de minute, eliminand eficient bacteriile dăunătoare
Quick 15'	
Temperatura de spalare	Cold
Capacitatea maxima de rufe uscate	2 kg
Selectie viteza de rotatie (rpm)	800
Functii suplimentare	
Durata implicita program (hh:min)	00:15
Tip de rufe/Descriere	Încărcături mixte de bumbac și materiale sintetice cu grad mic de murdărie

Wool	
Temperatura de spalare	40°C
Capacitatea maxima de rufe uscate	2 kg
Selectie viteza de rotatie (rpm)	800
Functii suplimentare	 
Durata implicita program (hh:min)	01:07
Tip de rufe/Descriere	Textile din lâna sau cu procent mare de lâna care se spală manual sau la mașină. Program de spălare foarte delicată pentru ca articolele să nu intre la apă; pauze mai lungi în timpul derulării programului
Spin Only	
Temperatura de spalare	--
Capacitatea maxima de rufe uscate	8 kg
Selectie viteza de rotatie (rpm)	800
Functii suplimentare	
Durata implicita program (hh:min)	00:12
Tip de rufe/Descriere	Extra centrifugare cu viteză de centrifugare selectabilă.
Rinse & Spin	
Temperatura de spalare	--
Capacitatea maxima de rufe uscate	8 kg
Selectie viteza de rotatie (rpm)	1000
Functii suplimentare	 
Durata implicita program (hh:min)	00:20
Tip de rufe/Descriere	Clatire suplimentara cu centrifugare
ECO 40-60	
Temperatura de spalare	--
Capacitatea maxima de rufe uscate	8 kg
Selectie viteza de rotatie (rpm)	1300
Functii suplimentare	
Durata implicita program (hh:min)	03:38
Tip de rufe/Descriere	Prestabilit la 40C, neselectabil, adecvat pentru spălare la aproximativ 40C-60C. Indicat pentru hainele colorate
Drum Clean	
Temperatura de spalare	90°C
Capacitatea maxima de rufe uscate	-
Selectie viteza de rotatie (rpm)	1000
Functii suplimentare	
Durata implicita program (hh:min)	01:18
Tip de rufe/Descriere	Program special pentru a curăța tamburul și cuva. Acest program aplică sterilizare la temperatură ridicată de 90 °C. Când se folosește acest program, nu se introduc haine în cuva. Când se introduce cantitatea adecvată de agent de albire cu clor, efectul de curățare a cuvei va fi mai bun.

Steam Wash	
Temperatura de spalare	40°C
Capacitatea maxima de rufe uscate	2.5 kg
Selectie viteza de rotatie (rpm)	800
Functii suplimentare	  
Durata implicita program (hh:min)	01:48
Tip de rufe/Descriere	Spălarea cu aburi poate pătrunde adânc în fibre, eliminand bacteriile și germenii, prevenind mirosurile și protejând sănătatea.
Sports	
Temperatura de spalare	20°C
Capacitatea maxima de rufe uscate	4 kg
Selectie viteza de rotatie (rpm)	1000
Functii suplimentare	  
Durata implicita program (hh:min)	00:45
Tip de rufe/Descriere	Program dedicat articolelor sportive



Viteză de centrifugare la stoarcere

Apăsați acest buton pentru a schimba viteza de centrifugare. 0-400-600-800-1000-1200-1300



Temporizare

Activarea funcției de amânare a pornirii:

1. Selectați un program.
2. Apăsați butonul Delay (Temporizare) pentru a selecta duratei (durata de temporizare este de 0-24h)
3. Apăsați butonul [Start/Pause] pentru a iniția procesul de amânare.



Pentru a anula funcția de **Temporizare**, apăsați butonul [Delay] înainte de lansarea programului până când pe afișaj apare valoarea 0 h. Dacă programul este deja pornit, opriți și reporniți mașina și selectați un program nou.



Pre Wash (Prespalare)

Funcție de spălare suplimentară, preliminară lansării ciclului principal, pentru rezultate de curățare mai bune. Observație: Se va adăuga detergent în compartimentul I



ExtraRinse (Clatire suplimentara)

Prin selectarea acestei funcții, rufe vor fi clătite suplimentar.



Temp.

Apăsați acest buton pentru reglarea temperaturii (20°C, 30°C, 40°C, 60°C, 90°C).



Blocare împotriva utilizării copiilor

Această funcție permite evitarea utilizării necorespunzătoare de către copii.



Apăsați cel două butoane timp de 3 secunde, pentru activarea acestora.

Atenție!

Apăsați cel două butoane timp de 3 secunde, atât pentru activarea funcției, cât și pentru dezactivarea acestora.

Funcția de „Protecție împotriva acționării de către copii” va bloca toate butoanele, cu excepția butonului [On/Off].

În cazul întreruperii alimentării cu energie electrică, funcția de protecție va fi dezactivată. În cazul anumitor modele, funcția va rămâne activă după restabilirea alimentării cu energie electrică.



Anularea semnalelor sonore

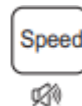

Apăsați butonul [Speed] timp de 3 secunde, pentru a trece pe modul silențios.

Pentru a activa funcția de semnale sonore, apăsați din nou butonul timp de 3 secunde. Această setare se va păstra până la următoarea resetare

8. MENTENANTA

Curățare și îngrijire

Curățarea și întreținerea

- Scoateți ștecherul din priză și închideți robinetul de apă înainte de a realiza lucrările de curățare și întreținere.

Curățarea exteriorului

O întreținere corectă a mașinii de spălat poate prelungi durata de viață a acesteia. Exteriorul acesteia se poate curăța cu detergenți neutri neabrazivi, diluați, la nevoie. Dacă observați scurgeri de apă pe suprafața mașinii, ștergeți imediat cu o cârpă. Nu folosiți niciodată obiecte ascuțite pentru a curăța mașina.

- Nu folosiți niciodată agenți abrazivi sau caustici, acizi formici sau solvenți diluați ai acestora, nici alte substanțe, precum: alcool sau agenți chimici

Curățarea tamburului

Orice urme de rugină lăsate în interiorul tamburului de obiectele metalice trebuie îndepărtate imediat, folosind detergenți fără clor. Nu folosiți niciodată un burete metalic pentru a curăța tamburul

Curățarea garniturii ușii și a geamului

Ștergeți geamul și garnitura după fiecare spălare pentru a îndepărta scamele și petele. Acumularea de scame poate determina scurgeri de apă. Îndepărtați orice monede, nasturi și alte obiecte rămase în garnitură după fiecare spălare. Curățați garnitura și geamul ușii o dată pe lună pentru a asigura funcționarea normală a mașinii.

Curățarea filtrului interior

1. Închideți robinetul și scoateți furtunul de alimentare cu apă.
2. Curățați filtrul cu o perie.
3. Deșurubați furtunul de alimentare cu apă din spatele mașinii. Trageți filtrul cu un clește cu vârf lung.
4. Curățați filtrul cu o perie.
5. Remontați filtrul la loc pe admisia de apă și reconectați furtunul de alimentare cu apă.
6. Curățați filtru interior o dată la 3 luni pentru a asigura funcționarea normală a mașinii.

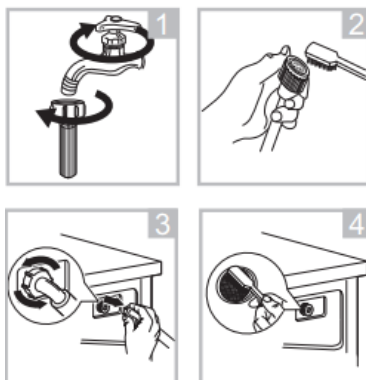

Curățarea dozatorului de detergent

1. Apăsăți în jos locația săgeții de pe capacul balsamului din interiorul sertarului dozatorului.
2. Ridicați capacul compartimentului pentru balsam din sertarul dozatorului și spălați ambele elemente cu apă.
3. Puneți la loc capacul compartimentului pentru balsam și împingeți sertarul la loc.



Curățați interiorul cu o perie moale.
Puneți la loc sertarul dozatorului

Curățarea filtrului pompei de evacuare

1. Atenție la apa fierbinte!
2. Pentru evitarea riscului de electrocutare, scoateți mașina de spălat din priză înainte de curățarea filtrului.
3. Filtrul pompei de evacuare poate reține obiecte mici în timpul spălării.
4. Curățați periodic filtrul, pentru a asigura funcționarea normală a mașinii de spălat.

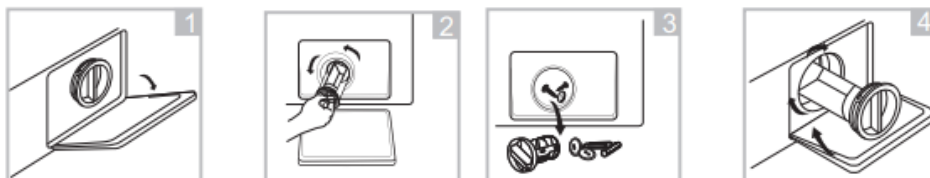

9. DEPANARE

În cazul în care mașina nu pornește sau se oprește în timpul funcționării, încercați mai întâi să depistați problema conform instrucțiunilor din tabelul de mai jos, apoi apelați la un centru de reparații.

Descriere	Cauză	Soluție
Mașina de spălat nu pornește	Ușa nu este închisă bine	Reporniți mașina de spălat după închiderea ușii. Asigurați-vă că rufele nu împiedică închiderea ușii
Ușa nu poate fi deschisă	Sistemul de siguranță al mașinii este în funcțiune.	Opriti și reporniți alimentarea cu energie
Scurgeri de apă	Racordurile furtunului de admisie sau evacuare nu sunt strânse suficient	Verificați și strângeți bine racordurile Curățați furtunul de evacuare
Sunt prezente reziduuri de detergent în sertar.	Detergentul este umed sau a format bulgări	Curățați și ștergeți sertarul pentru detergent
Indicatoarele luminoase sau afișajul nu funcționează	Probleme de alimentare	Asigurați-vă că alimentarea este pornită și că ștecărul este conectat corect
Zgomote neobișnuite		Asigurați-vă că șuruburile de fixare au fost îndepărtate Asigurați-vă că mașina este amplasată pe o podea solidă și plană

CODURI DE EROARE

Descriere	Cauză	Soluție
E30	Ușa nu este închisă bine	Reporniți mașina de spălat după închiderea ușii Asigurați-vă că rufele nu împiedică închiderea ușii
E10	Probleme cu injectarea apei în timpul spălării	Asigurați-vă că presiunea de alimentare cu apă nu este prea scăzută Îndreptați furtunul de admisie. Verificați furtunul de admisie Asigurați-vă că filtrul de admisie nu este înfundat
E21	Evacuarea apei nu este corespunzătoare	Asigurați-vă că furtunul de evacuare nu este înfundat
E12	Preaplin apă	Reporniți mașina de spălat
EXX	Altele	Faceți toate verificările necesare, apoi apelați la un centru de reparații.

SERVICE ȘI ASISTENȚĂ PENTRU CLIEȚI

Utilizați numai piese de schimb originale.

Când contactați centrul nostru de service autorizat, asigurați-vă că aveți la îndemână următoarele informații:
Denumirea modelului și numărul de serie.

Informațiile pot fi găsite pe plăcuța cu date tehnice. Acestea pot suferi modificări fără o notificare prealabilă.

DATE TEHNICE

Informațiile tehnice se află pe plăcuța cu date tehnice a aparatului și pe eticheta energetică.

Codul QR de pe eticheta energetică furnizată împreună cu aparatul oferă un link web către informațiile din baza de date EPREL cu privire la performanțele aparatului.

Păstrați eticheta energetică pentru consultări ulterioare, împreună cu manualul de utilizare și cu toate celelalte documente furnizate împreună cu acest aparat.

De asemenea, puteți găsi aceleași informații în baza de date EPREL, folosind link-ul <https://eprel.ec.europa.eu> și denumirea modelului și numărul de serie al produsului, pe care le găsiți pe plăcuța cu date tehnice a aparatului.

Pentru a accesa informațiile despre produsul Dvs în portalul EPREL, puteți scana codurile de mai jos:



Vă mulțumim pentru achiziționarea acestui produs! Dacă aveți nevoie de asistență în ceea ce privește produsul dumneavoastră, vizitați site-ul nostru web utilizând linkurile de mai jos:

Get User manuals: <https://www.heinner.ro>

Get Service information: <https://www.heinner.ro>



MASURI PENTRU PROTECTIA MEDIULUI

Va informam ca persoanele fizice au urmatoarele obligatii prin legislatia specifica privind protectia mediului si regimul deseurilor:

- Deseurile de echipamente electrice si electronice (DEEE), pot contine substante periculoase pentru mediu si sanatatea umana. Conform OUG 5/2015, exista obligativitatea predarii acestora, pentru tratarea corespunzatoare si valorificarea componentelor reciclabile. Societatea Network One Distribution S.R.L. este platitoare de taxa de "timbru verde" pentru fiecare Echipament Electric si Electronic (EEE) pe care il pune pe piata. Acest cost asigura tratarea ulterioara a echipamentelor uzate colectate. Din acest motiv, odata ce devine deseu, produsul EEE poate fi predat gratuit operatorului Dvs. de salubritate, la magazine atunci cand achizitionati alt echipament similar, sistemul "unul la unu" sau la punctul de colectare organizat de Primaria Sectorului / localitatii Dvs.
- Simbolul (marcajul) aplicat produselor, care indica faptul ca deseurile DEEE, bateriile si acumulatorii - fac obiectul unei colectari separate, il reprezinta o pubela barata cu o cruce.



Aceste masuri vor ajuta la protejarea mediului

Societatea Network One Distribution S.R.L. este inregistrata in Registrul de punere pe piata a echipamentelor electrice si electronice, avand numarul de inregistrare: RO-2016-03-EEE-0201-IV. De asemenea, au fost intocmite si sunt gestionate: Registrul de Retragere EEE si Registrul de Rechemare EEE, in conformitate cu HG 322/2013. Totodata societatea este inregistrata in Registrul de punere pe piata a bateriilor, avand numarul de inregistrare: RO-2011-03-B&A-0283.

Conformitatea cu directiva RoHS: Produsul pe care l-ati cumparat este conform cu Directiva RoHS UE (2011/65/UE). Nu contine materialele daunatoare si interzise specificate in Directiva.

Va multumim ca participati alaturi de noi la protejarea mediului si a sanatatii umane!



HEINNER este marcă înregistrată a companiei **Network One Distribution SRL**. Celelalte branduri și denumirile produselor sunt mărci de comerț sau mărci de comerț înregistrate ale respectivilor deținători.

Nicio parte a specificațiilor nu poate fi reprodusă, sub nicio formă și prin niciun mijloc, nici utilizată pentru obținerea unor derivate precum traduceri, transformări sau adaptări, fără consimțământul prealabil al companiei NETWORK ONE DISTRIBUTION.

Copyright © 2013 Network One Distribution. Toate drepturile rezervate.

www.heinner.com, <http://www.nod.ro>

<http://www.heinner.com>, <http://www.nod.ro>



Acest produs este proiectat și realizat în conformitate cu standardele și normele Comunității Europene.



Importator: **Network One Distribution**

Str. Marcel Iancu, nr. 3-5, București, România

Tel: +40 21 211 18 56, www.heinner.com, www.nod.ro

АВТОМАТИЧНА ПЕРАЛНА МАШИНА

Модел:
HWM-TL8013IVA++



- Перална машина
- Товароносимост: 8 kg
- Енергиен клас: А

HEINNER

1. ВЪВЕДЕНИЕ

Моля прочетете внимателно инструкциите и запазете наръчника за бъдещи справки.

Този наръчник има за цел да Ви предостави всички необходими инструкции по отношение на инсталирането, използването и поддържането на уреда. Преди инсталиране и използване на уреда, с цел правилна и безопасна употреба на уреда, моля прочетете внимателно този наръчник с инструкции.

2. СЪДЪРЖАНИЕ НА ВАШИЯ ПАКЕТ

- ➔ Перална машина
- ➔ Наръчник за употреба
- ➔ Сертификат за гаранция

3. ПРЕДУПРЕЖДЕНИЯ ОТНОСНО БЕЗОПАСНОСТТА

ОПАСНОСТ ОТ ТОКОВ УДАР!

- За предотвратяване на опасностите, ако захранващият кабел е повреден, трябва да се подмени от производителя, от сервиза или от лица с подобна квалификация.
- Моля, използвайте новите маркучи, доставени заедно с пералната машина. Старите маркучи не трябва да се използват повторно.
- Преди извършване на всякакви операции за поддръжка, изключете уреда от източника за захранване с електроенергия.
- След всяка употреба на уреда изключвайте го от източника на захранване и спрете захранването с вода. Максималната стойност на налягането на подадената вода е посочена в паскали (Pa). Минималната стойност на налягането на подадената вода е посочена в паскали (Pa).
- За Вашата безопасност, щепселът на захранващия кабел трябва да се включва в триполюсен контакт, предвиден със заземяване. Проверете внимателно и се уверете, че контактът е заземен по съответстващ начин.
- Уверете се, че уреда е свързан към водопроводната мрежа и електрическата мрежа от квалифициран техник, в съответствие с инструкциите на производителя и местните разпоредби за безопасност.
- Изключете захранващият кабел, преди операциите за почистване или поддръжка.
- Не използвайте неподходящ контакт за захранване на пералната машина. Не изваждайте щепсела от контакта с мокри ръце.
- Не забравяйте да изключите пералнята от водопроводната мрежа и от електрическата мрежа веднага след изпиране на дрехите.

ОПАСНОСТ ЗА ДЕЦАТА!

- Уредът може да се използва от деца на възраст най-малко 8 години и от лица с намалени физически, сетивни или умствени способности, или с липса на достатъчен опит и познания, само ако са под наблюдение или са получили указания във връзка с използването на уреда по безопасен начин и ако разбират опасностите, които могат да възникнат при използване на уреда. Децата нямат право да си играят с уреда. Почистването и поддръжката не трябва да се извършват от деца, които не са под наблюдение.
- Децата на възраст под 3 години трябва да се намират под наблюдение, така че да не си играят с уреда.

- Уверете се, че животни и деца не влизат в пералната машина. Проверявайте пералната машина преди всяка употреба.
- Децата трябва да бъдат под наблюдение, така че да не си играят с уреда.
- Стъклената врата може да стане много гореща по време на функциониране. Пазете децата и домашните любимци далеч от пералнята по време на функциониране в много влажни помещения или в стаи с взривни или корозивни газове.

ОПАСНОСТ ОТ ВЗРИВ!

- Не изпирайте и не изсушавайте изделия, които са почистени, изпрани или накиснати във запалими или взривни вещества (восък, масло, боя, бензин, обезмаслител, разтворители за химическо чистене, керосин и др.), защото има опасност от възникване на пожар или взрив.
- Прането не трябва да се изсушава в уреда, ако са използвани промишлени химични вещества за тяхното почистване.
- Изведеният въздух не трябва да се освобождава в канал за дим с цел извеждане на изгорелите газове вследствие на употребата на други уреди.
- Преди тяхното поставяне в пералнята изплакнете ги добре ръчно.

ИНСТАЛИРАНЕ НА ПРОДУКТ

- Този уред е предназначен за използване само в закрити помещения.
- Тя не е предназначена за използване като вграден уред.
- Не покривайте отворите на пералната машина с текстилни материали или с други предмети.
- Пералните машини не могат да бъдат поставени в бани или стаи с голяма влажност, или в стаи с взривоопасни или разяждащи газове.
- Перилните машини с една входяща дюза за вода се свързват само към източника за студена вода. Перилните машини с двойна входяща дюза за вода се свързват към източника за студена и към източника за топла вода.
- Щепселът трябва да бъде достъпен след инсталиране на пералнята.
- Уредът не трябва да се инсталира зад блокируема врата, зад плъзгаща врата или зад врата с панта в противоположната страна на сушилнята за дрехи.
- Уредът не трябва да се инсталира в помещение с висока влажност.
- Този домакински електроуред не е предназначен за вграждане.
- Отстранете всички опаковки и болтовете за транспортиране преди употреба на пералнята. В противен случай могат да се появят сериозни повреди.

РИСК ОТ ПОВРЕЖДАНЕ НА УРЕДА!

- Продуктът е предназначен само за домашна употреба и за изпиране и изсушаване на текстилни изделия, които могат да се изпират и изсушават с този продукт.
 - Не се качвайте и не сядайте върху капака на пералната машина.
 - Не се подпирайте на вратата на пералната машина.
- Мерки за безопасност по време на маневриране на пералната машина:
 1. Транспортните болтове трябва да се монтират отново само от квалифициран техник.
 2. Акумулираната вода трябва да бъде изведена от пералнята.
 3. Боравяйте внимателно с пералнята. Когато вдигате пералнята, не я хващайте за издадените части. По време на преместване на пералнята, нейната врата не трябва да се използва като дръжка.
 4. Уредът е тежък. Транспортирайте го внимателно.
 5. Не поставяйте ръцете в барабана тогава, когато се върти.

- Моля не затваряйте вратата прилагайки прекалено голяма сила. Ако вратата се затваря трудно, проверете дали няма твърде много дрехи във ваната или дали са разпределени по съответстващ начин.
- Изпирането на килими е забранено

4. ОПИСАНИЕ НА ПРОДУКТ

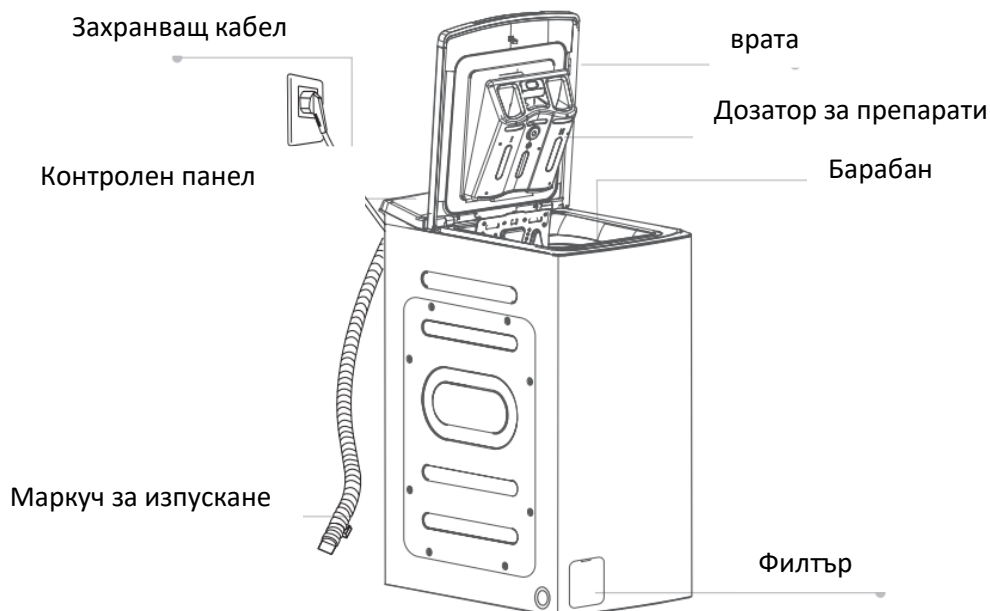

АКСЕСОАРИ

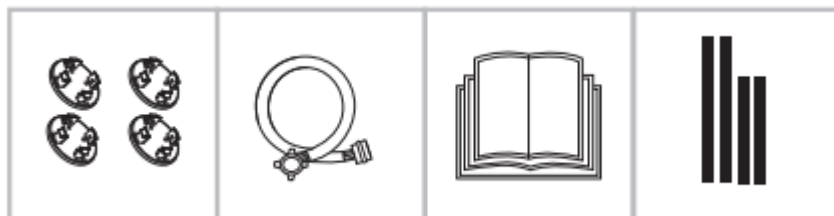

- 4 x Капачки
- 1 x Маркуч за захранване със студена вода
- 1 x Наръчник за употреба
- Акустична гъба

5. КОНТРОЛЕН ПАНЕЛ

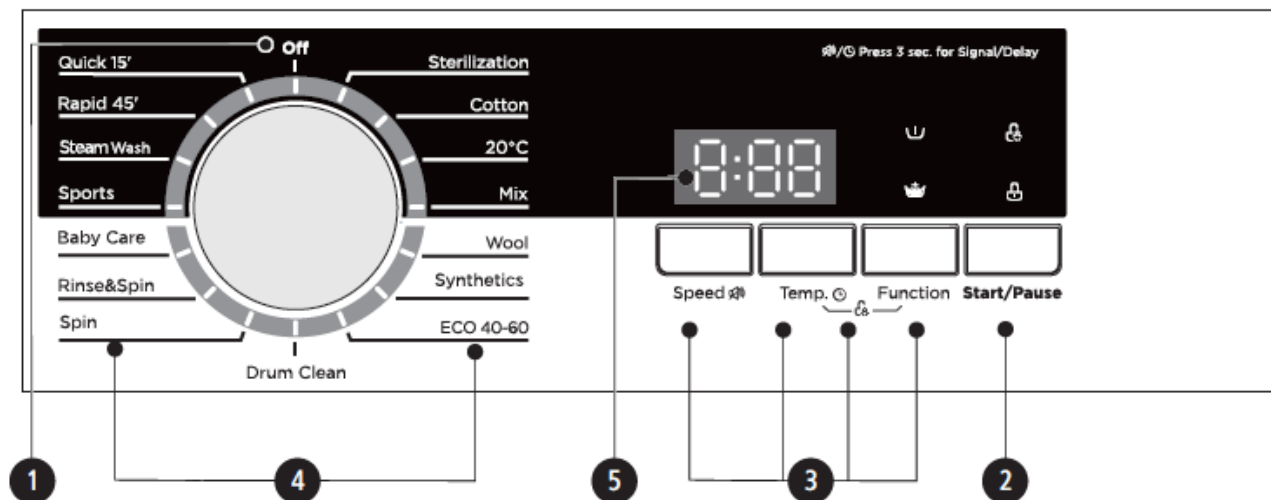

1. ON/OFF (Включване/Изключване)

Бутон за включване или изключване на уреда.

2. START/PAUSE (Старт/Пауза)

Натиснете този бутон с цел включване или прекъсване на програмата за изпиране.

3. ОПЦИИ

Тези бутони Ви позволяват избора на допълнителни функции.

4. ПРОГРАМИ

Съществуващи програми в зависимост от вида на дрехите.

5. ЕКРАН

Екранът показва настройките, прогнозираното време до края на програмата, опциите и съобщенията за състоянието на Вашата пералня. Екранът остава включен по време на действие на програмата за изпиране.

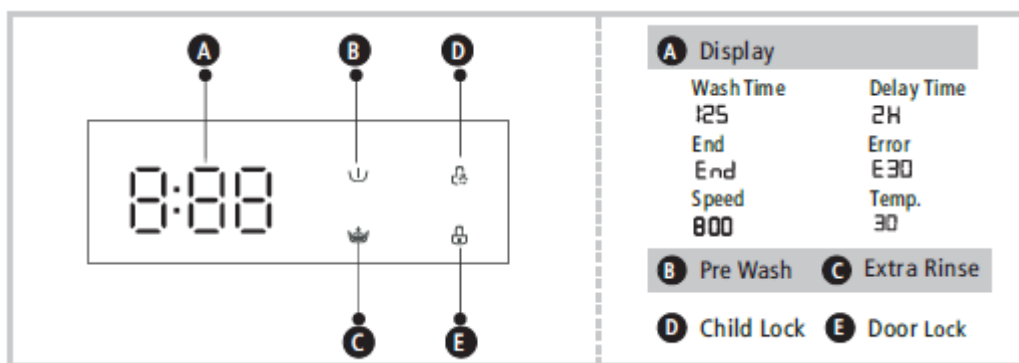

- A- Дисплей
- B- Предпране
- C- Допълнително изплакване
- D- Заклучване за деца
- E- Брава за врата

6. ИНСТАЛАЦИЯ

Място на инсталацията

ПРЕДУПРЕЖДЕНИЕ!

- Стабилността на пералнята е много важна с цел предотвратяване на нейното предвижване по време на функциониране.
- Уверете се, че пералнята не е поставена върху хранващия кабел

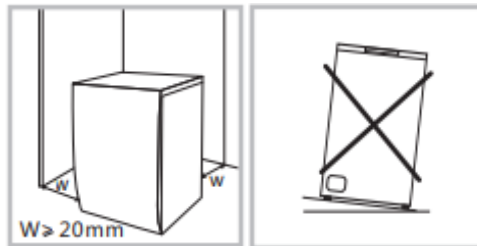

Преди да се инсталира пералнята, трябва да изберете място за инсталиране, което да има следните характеристики:

1. Твърдо, сухо и равно място.
2. Предотвратете поставянето на пряка слънчева светлина.
3. Уверете се, че мястото е достатъчно проветриво.
4. Стойността на температурата на стаята трябва да надвишава 5°C.
5. Не поставяйте пералнята в близост до източници на топлина, като тези въз основа на въглища или газ.

Разопаковане на пералнята

- Опаковъчният материал (напр. филми, стиропор) може да бъде опасен за децата.
- Има опасност от задушаване!
- Пазете всички опаковки далеч от деца.

1. Отстранете картонената кутия и опаковката от стиропор.
2. Повдигнете пералнята и отстранете основната опаковка. Уверете се, че малката триъгълна пяна е отстранена заедно с долната. Ако не, поставете уреда със странична повърхност, след което отстранете ръчно малката пяна от дъното на уреда.
3. Отстранете лентата, закрепваща хранващия кабел и маркуча за източване.
4. Отстранете маркуча за подаване на вода от барабана. Уверете се, че малкият триъгълник.

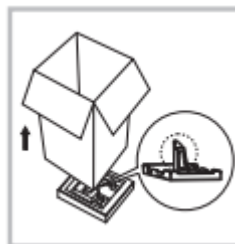

Отстраняване на болтовете за транспортиране

ПРЕДУПРЕЖДЕНИЕ!

- Преди употреба на продукт е необходимо да извадите болтовете за транспортиране от неговата задна страна.
- Ще имате нужда от тези болтове, ако желаете да транспортирате продукта, така че съхранявайте ги на сигурно място.

Следвайте стъпките подолу:

1. Разхлабете с ключ 4-те болта и извадете ги.
2. Покрийте отворите с предоставените капачки.
3. Съхранявайте болтовете за транспортиране, за да можете да ги използвате впоследствие

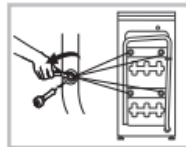

НИВЕЛИРАНЕ НА ПЕРАЛНАТА МАШИНА

ПРЕДУПРЕЖДЕНИЕ! Гайките за фиксиране от четирите крачета трябва да се стягат добре за корпуса.

1. Уверете се, че крачетата са добре захванати за корпуса. В противен случай, поставете ги в първоначалната позиция и стегнете гайките.
2. Разхлабете гайките за фиксиране и завъртете крачетата, докато стигнат до пода.
3. Регулирайте крачетата и уверете се, пералнята е стабилна.



СВЪРЗВАНЕ НА МАРКУЧА ЗА ЗАХРАНВАНЕ С ВОДА

- Поставете дренажния маркуч правилно, в противен случай повредата може да се дължи на изтичане на вода.

- Не прегъвайте и не удължавайте дренажния маркуч

Има два начина за поставяне на края на дренажния маркуч:

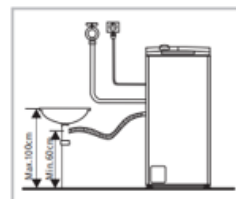
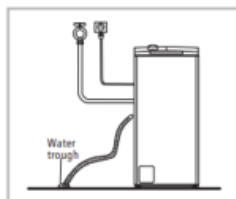

- Ако машината има опора за дренажен маркуч, моля, монтирайте я по следния начин

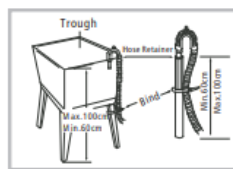
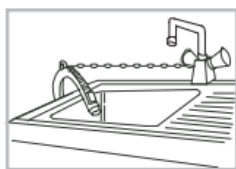

- Когато монтирате дренажен маркуч, фиксирайте го правилно с въже
- Ако дренажният маркуч е твърде дълъг, не го пъхайте насила в пералната машина, тъй като това ще предизвика необичайни шумове.

7. Операция

- Преди употреба на пералнята, уверете се, че е инсталирана по съответстващ начин.
- Преди първото изпиране на дрехи, пералнята трябва да извърши един пълен цикъл на изпиране, без пране, поставено вътре в нея.

Преди измиване

- Трябва да добавите препарат в "случай I", след като изберете предварително пране за машини с тази функция.
- Уверете се, че клапите на барабана са правилно заключени.

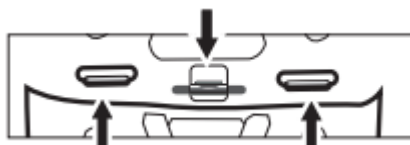

- Всички метални куки трябва да бъдат правилно закачени вътре в капака на задната врата.
- Проверявайте ролката преди всяко пране, тя трябва да се върти гладко.

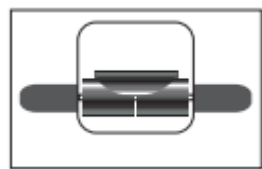

1. Включете в контакта
2. Отворете крана
3. Заредете
4. Добавете перилен препарат
5. Затворете вратата на барабана
6. Затворете вратата на машината

Пране и след пране

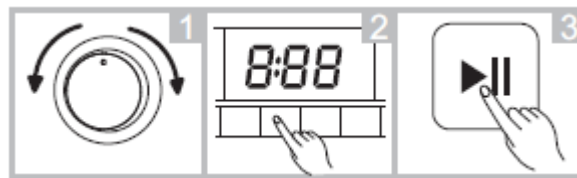

“End” на дисплея.

ПРЕДИ ВСЯКО ИЗПИРАНЕ

- Температурата за функциониране на пералната машина трябва да се намира в интервала (5-40)°C. Ако пералнята се съхранява в среда с температура 0°C или по-ниска, уредът трябва да се премести в среда с по-висока температура, за да се уверите, че маркучът за захранване с вода и този за извеждане не са замръзнали преди употреба.
- Преди да започнете изпирането, прочетете информацията върху етикетите и обясненията във връзка с начина на употреба на перилния препарат. Използвайте перилни препарати, които не образуват пяна или които образуват малко количество пяна и са подходящи за перална машина.



Прочетете информацията върху

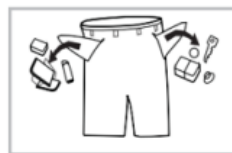

Извадете предметите от джобовете

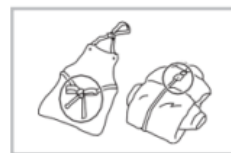

Връзвайте на възел дългите колани, закопчайте циповете и копчетата

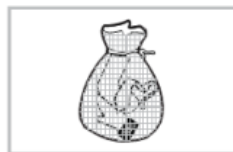

Поставете малките изделия в калъфа за възглавница или в специален сак



Обърнете наопаки изделията, които образуват лесно власинки и изделията с дълга нишка

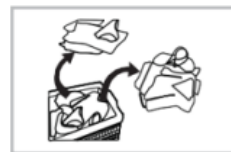

Отделете дрехите с различни видове тъкани

- При изпиране на една единствена дреха, ваната на пералната машина може да функционира по несъответстващ начин поради нарушаване на равновесието. Следователно Ви препоръчваме да добавите и други дрехи, така че извеждането на водата да се извършва по съответстващ начин.
- Не изпирайте дрехи, които са влезли в контакт с керосин, бензин, етилов алкохол или други запалими вещества

ЧЕКМЕДЖЕ ЗА ПЕРИЛЕН ПРЕПАРАТ

- I Перилен препарат за предпране
- II Перилен препарат за основно изпиране
-  Омекотител

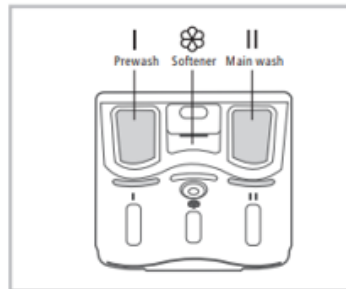

Зареждането с перилен препарат на отделение "I" е необходимо само при избор на функцията за предпране за пералните, които имат тази функция

- Не превишавайте маркировката за ниво "MAX", когато пълните перилен препарат, добавки или омекотител.

Program	I	II		Program	I	II	
Sterilization		●	○	Spin			
Cotton	○	●	○	Rinse and spin			○
20 C	○	●	○	Baby care	○	●	○
Mix	○	●	○	Sports	○	●	○
Wool		●	○	Steam Wash	○	●	○
Synthetics	○	●	○	Rapid 45'		●	○
ECO 40-60		●	○	Quick 15'		●	○
Drum Clean							

- Означава задължително
- Означава опционално

- Агломерацията или влакнест перилен препарат или добавка може да се разтвори в малко вода, преди да се излее в дозатора за перилен препарат, за да се избегне блокиране на входа му и по този начин да се причини преливане на вода.
- Моля, изберете подходящия тип перилен препарат, за да получите максимална ефективност на пране и минимална консумация на вода и енергия
- За постигане на най-добър резултат от почистване е важно правилното дозиране на препарата.
- Използвайте намалено количество препарат, ако барабанът не е пълен напълно.
- Винаги съобразявайте количеството на препарата с твърдостта на водата, ако чешмяната ви вода е мека, използвайте по-малко препарат.
- Дозирайте според това колко мръсно е прането ви, по-малко мръсните дрехи изискват по-малко перилен препарат.

- Силно концентриран (компактен препарат) изисква особено точно дозиране.



Следните симптоми са признак за предозиране на перилен препарат:















- образуване на силна пяна
- лош резултат от пране и изплакване

Следните симптоми са признак на недостатъчна доза перилен препарат:







- прането става сиво
- натрупване на варовик върху барабана, нагревателния елемент и/или прането

Цикъл	Номинален капацитет в кг	Продължителност на цикъла в часове и минути	Консумация на енергия в kWh/работен цикъл	Консумация на вода в литри/работен цикъл	най-висока температура (С)	Остатъчна влага в % /скорост на центрофуга в об./мин
Quick 15'	2.0	0:15	0.026	34	студен	70%/800
20С	4.0	1:01	0.183	47	20	70%/800
Cotton	8.0	2:45	1.394	71	60	53%/1300
Synthetics	4.0	2:20	0.625	44	40	70%/800
Mix	8.0	1:20	0.754	71	40	70%/800
ECO 40-60	8.0	3:38	0.739	57	-	53.9%/1250
	4.0	2:48	0.456	47	-	53.9%/1250
	2.0	2:48	0.196	38	-	53.9%/1250

Cotton	
Температура на изпиране	40°C
Максимално количество сухо пране	8 kg
Избор на скорост на въртене (rpm)	1000
Допълнителни функции	
Продълж. на програмата по подразбиране	02:40
Вид на прането/описание	Дрехи устойчиви на износване и топлина, изработени от памук или лен.
Synthetic	
Температура на изпиране	40°C
Максимално количество сухо пране	4 kg
Избор на скорост на въртене (rpm)	1000
Допълнителни функции	
Продълж. на програмата по подразбиране	02:20
Вид на прането/описание	Препоръчана с цел изпиране на синтетични изделия: блузи, якета, изделия от смес на синтетични фибри и др. Тогава, когато перете трикотажни изделия, количеството на перилния препарат трябва да се намали с цел предотвратяване образуването на прекалено голямо количество пяна.

Baby Care	
Температура на изпиране	60°C
Максимално количество сухо пране	8 kg
Избор на скорост на въртене (rpm)	1000
Допълнителни функции	  
Продълж. на програмата по подразбиране	02:01
Вид на прането/описание	Изпирането на дрехите на бебето може да направи дрехите на бебето по-чисти и да направи изплакването по-добро, за да защити бебешката кожа.
Rapid 45'	
Температура на изпиране	40°C
Максимално количество сухо пране	2 kg
Избор на скорост на въртене (rpm)	1000
Допълнителни функции	 
Продълж. на програмата по подразбиране	00:45
Вид на прането/описание	Пране на малко и не много мръсни дрехи бързо
Mix	
Температура на изпиране	40°C
Максимално количество сухо пране	8 kg
Избор на скорост на въртене (rpm)	1000
Допълнителни функции	  
Продълж. на програмата по подразбиране	01:20
Вид на прането/описание	Смесено зареждане на памучни и синтетични дрехи
20°C	
Температура на изпиране	20°C
Максимално количество сухо пране	4 kg
Избор на скорост на въртене (rpm)	1000
Допълнителни функции	  
Продълж. на програмата по подразбиране	01:01
Вид на прането/описание	Прането на ярко оцветени дрехи може да защити цветовете по-добре
Sterilization	
Температура на изпиране	70°C
Максимално количество сухо пране	4 kg
Избор на скорост на въртене (rpm)	1000
Допълнителни функции	 
Продълж. на програмата по подразбиране	02:27
Вид на прането/описание	Поддържайте температурата на пране над 60 градуса за повече от 30 минути, ефективно премахване на вредните бактерии
Quick 15'	
Температура на изпиране	Cold
Максимално количество сухо пране	2 kg
Избор на скорост на въртене (rpm)	800
Допълнителни функции	
Продълж. на програмата по подразбиране	00:15
Вид на прането/описание	Тази програма е подходяща за бързо изпиране на малък брой дрехи, които са леко замърсени

Wool	
Температура на изпиране	40°C
Максимално количество сухо пране	2 kg
Избор на скорост на въртене (rpm)	800
Допълнителни функции	 
Продълж. на програмата по подразбиране	01:07
Вид на прането/описание	Текстил от вълна или богата вълна, която може да се мие ръчно или в машина. Особено нежна програма за пране, за да се предотврати свиването, по-дълги паузи на програмата (текстилът почива в течност за пране).
Spin Only	
Температура на изпиране	--
Максимално количество сухо пране	8 kg
Избор на скорост на въртене (rpm)	1000
Допълнителни функции	
Продълж. на програмата по подразбиране	00:12
Вид на прането/описание	Допълнително центрофугиране с възможност за избор на скоростта за центрофугиране
Rinse & Spin	
Температура на изпиране	--
Максимално количество сухо пране	8 kg
Избор на скорост на въртене (rpm)	1000
Допълнителни функции	 
Продълж. на програмата по подразбиране	00:20
Вид на прането/описание	Допълнително изплакване с центрофугиране.
ECO 40-60	
Температура на изпиране	--
Максимално количество сухо пране	8 kg
Избор на скорост на въртене (rpm)	1300
Допълнителни функции	
Продълж. на програмата по подразбиране	03:38
Вид на прането/описание	Прането на ярко оцветени дрехи може да защити цветовете по-добре. По подразбиране 40°C, не може да се избира, подходящо за пране при около 40°C-60°C
Drum Clean	
Температура на изпиране	90°C
Максимално количество сухо пране	-
Избор на скорост на въртене (rpm)	1000
Допълнителни функции	
Продълж. на програмата по подразбиране	01:18
Вид на прането/описание	Специално поставен в тази машина за почистване на барабана и тръбата. Прилага се 90 °C високотемпературна стерилизация, за да направи дрехите пране повече зелено. Когато се изпълнява тази програма, дрехите или др пране не може да се добави. Когато правилното количество хлорно избелване се постави агент, ефектът от почистване на цвята ще бъде по-добър. Клиентът може да използва тази програма редовно според нуждите..

Steam Wash	
Температура на изпиране	40°C
Максимално количество сухо пране	2.5 kg
Избор на скорост на въртене (rpm)	800
Допълнителни функции	  
Продълж. на програмата по подразбиране	01:48
Вид на прането/описание	Парната баня може да проникне дълбоко във влакната, което ефективно елиминира бактериите и микробите, предотвратява миризмите и предпазва здравето.
Sports	
Температура на изпиране	20°C
Максимално количество сухо пране	4 kg
Избор на скорост на въртене (rpm)	1000
Допълнителни функции	  
Продълж. на програмата по подразбиране	00:45
Вид на прането/описание	Пране на активното облекло.

Spin

Скорост на въртене

Когато е необходимо, скоростта на центрофугиране може да се регулира чрез натискане на бутона Speed в следните стъпки: 0-400-600-800-1000-1200-1300

Delay

DELAY (Отложено включване)

Активиране на функцията за отложено включване (таймер):

1. Изберете една програма.
2. Натиснете бутона Delay (Таймер / Отложено включване) с цел настройка на времетраенето (времетраенето на таймер е между 0-24h часа)
3. Натиснете бутона Start/Pause с цел активиране на функцията за отложено включване (таймер).



Анулиране на функцията за отложено включване (таймер):

Задръжте натиснат бутона [Delay], докато се покаже върху екрана надпис 0H.

**PRE-WASH (Предпране)**

Тази функция позволява предпране на дрехите преди основното изпиране.

Тогава, когато избирате тази функция, е необходимо да поставите перилен препарат в отделение "I".

**EXTRA RINSE (Допълнително изплакване)**

Избирането на тази функция активира допълнителното изплакване на дрехите.



ТЕМПЕРАТУРА

Натиснете този бутон с цел настройка на температурата (Студена вода, 20°C, 40°C, 60°C, 90°C)



ЗАЩИТА СРЕЩУ ЗАДЕЙСТВАНЕ ОТ ДЕЦА

Тази функция позволява предотвратяване на несъответстващата употреба от страни на деца.

Натиснете „Temp.“ и „Function“ 3 секунди до звуков сигнал.



Когато защитата за деца е активирана, дисплеят ще показва последователно „CL“ и оставащото време. Натискането на който и да е друг бутон ще доведе до мигане на индикатора Child Lock.

Когато програмата приключи, „CL“ и „END“ ще се редуват на дисплея.

Child Lock дезактивира функцията на всички бутони с изключение на бутона за включване/изключване и бутона за заключване за деца! Само едновременното натискане на двата бутона [Temp.] и [Function] може да дезактивира Child Lock! Моля, дезактивирайте Child Lock, преди да изберете нова програма!



ДЕЗАКТИВИРАНЕ НА ЗВУКОВОТО ПРЕДУПРЕЖДАВАНЕ



1. Изберете програмата
2. Натиснете „Speed“ за 3 секунди, зумерът е изключен. За да активирате функцията зумер, натиснете бутона отново за 3 секунди. Настройката ще се запази до следващото нулиране.

Внимание! След заглушаване на функцията зумер, звуците няма да се активират повече

8. ПОДДРЪЖКА

ПРЕДУПРЕЖДЕНИЕ! Преди извършване на операциите за поддръжка, изключете пералнята от източника за захранване с електроенергия и затворете крана.

ПОЧИСТВАНЕ НА КОРПУСА

Правилната поддръжка на пералната машина може да удължи периода за нейното използване. Тогава, когато е необходимо, повърхностите на корпуса могат да се почистват с неабразивен разреден неутрален перилен препарат. Ако водата прелее от пералнята, използвайте влажна кърпа, за да я избършете веднага. Не се позволява използването на остри предмети.

ЗАБЕЛЕЖКА: Използването на мравчена киселина и на разреждени разтворители (етилов алкохол, химични продукти и др.) е забранено.

ПОЧИСТВАНЕ НА ВАНАТА

Следите от ръжда, оставени във вътрешността на ваната от металните предмети, трябва да се отстранят веднага, като се използват перилни препарати, които не съдържат хлор. Не използвайте кухненски метални телчета.

ЗАБЕЛЕЖКА: Не поставяйте дрехи за пране във ваната по време на процедурата за почистване на ваната.

ПОЧИСТВАНЕ НА ГУМЕНОТО УПЛЪТНЕНИЕ И НА СТЪКЛОТО НА ВРАТАТА

Избършете гуменото уплътнение и стъклото на вратата след всяко изпиране с цел отстраняване на власинките и петната. Натрупването на власинки може да причини течове. След всяко изпиране отстранявайте монетите, копчетата и други предмети от гуменото уплътнение.

ПОЧИСТВАНЕ НА ВХОДЯЩИЯ ФИЛТЪР

ЗАБЕЛЕЖКА: Входящият филтър трябва да се почиства, ако количеството на водата, която е необходима за изпиране, намалява.

Почистване на филтъра при връзката с крана:

1. Затворете крана.
2. Извадете входящия маркуч от крана.
3. Почистете филтъра.
4. Свържете входящия маркуч към крана.

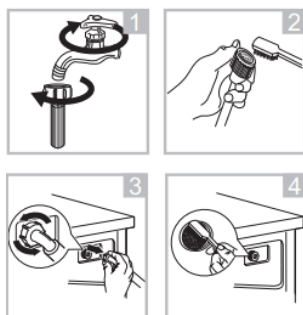

ПОЧИСТВАНЕ НА ЧЕКМЕДЖЕТО ЗА ПЕРИЛЕН ПРЕПАРАТ

1. Натиснете върху стрелката във вътрешността на чекмеджето за перилен препарат.
2. Вдигнете клапата и извадете капака на отделението за ароматизатор, след това измийте с вода всички отделения.
3. Поставете на място капака на отделението за ароматизатор и бутнете чекмеджето в своето гнездо.



ИЗМИЙТЕ ФИЛТЪРА НА ПОМПАТА ЗА ИЗТОЧВАНЕ ПРЕДУПРЕЖДЕНИЕ!

Внимавайте с горещата вода! Оставете разтвора с препарат за миене да се охлади. С цел предотвратяване на риска от токов удар, изваждайте пералната машина от контакта преди почистване на филтъра.

Филтърът на помпата за извеждане може да задържа малки предмети по време на изпиране.

Почиствайте периодично филтъра, за да осигурите нормално функциониране на пералната машина

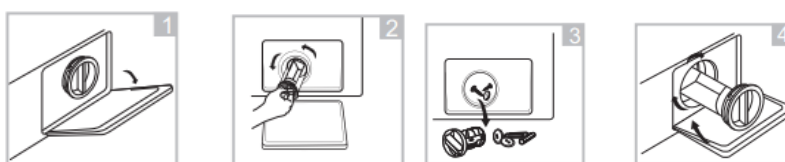

9. ОТСТРАНЯВАНЕ НА ПРОБЛЕМИ

Ако пералнята не се включва или се изключва по време на функциониране, опитайте първо да откриете проблема съгласно инструкциите от долната таблица, след това се обърнете към сервизен център.

Описание:	Причина	Решение
Пералната машина не се включва.	Вратата не е добре затворена.	Включете отново пералната машина след затваряне на вратата. Уверете се, че дрехите за изпиране не възпрепятстват затварянето на вратата.
Вратата не може да бъде отворена.	Системата за безопасност на пералнята е активирана.	Изключете и включете отново захранването с електроенергия.
Течове на вода	Връзките на входящия маркуч или на маркуча за извеждане не са стегнати достатъчно.	Проверете и стегнете добре връзките. Почистете маркуча за извеждане.
Има остатъци от перилен препарат в чекмеджето.	Перилният препарат е влажен или в него са се образували бучки.	Почистете и избършете чекмеджето за перилен препарат.
Светлинните индикатори или екранът не работят.	Проблеми със захранването с електроенергия.	Уверете се, че захранването е включено и че щепселът е свързан правилно.
Необичайни шумове.		Уверете се, че болтовете за фиксиране са отстранени. Уверете се, че пералнята е поставена върху здрав и равен под.

Описание:	Причина	Решение
E30	Вратата не е добре затворена.	Включете отново пералната машина след затваряне на вратата. Уверете се, че дрехите за изпиране не възпрепятстват затварянето на вратата.
E10	Проблеми с изпускането на водата по време на изпиране	Уверете се, че налягането на захранването с вода не е твърде ниско. Изправете входящия маркуч. Проверете маркуча за подаване на вода. Уверете се, че входящият маркуч не е запушен.
E21	Извеждането на водата не е съответстващо.	Уверете се, че маркучът за извеждане не е запушен.
E12	Прекомерно количество вода.	Включете отново пералната машина.
EXX	Други	Извършвайте всички необходими проверки, след това се обърнете към сервизен център.

СЕРВИЗ И ОБСЛУЖВАНЕ НА КЛИЕНТИ

Използвайте само оригинални резервни части.

Когато се свързвате с нашия оторизиран сервизен център, уверете се, че имате под ръка следната информация: Наименование на модела и сериен номер.

Информацията може да бъде намерена на табелката с технически данни. Те подлежат на промяна без предварително уведомление.

ТЕХНИЧЕСКИ ДАННИ

Техническата информация се намира на табелката с технически данни на уреда и на енергийния етикет.

QR кодът на енергийния етикет, предоставен заедно с уреда, предлага уеб връзка към информацията в базата данни на EPREL относно постиженията на уреда.

Запазете енергийния етикет за бъдещи справки, заедно с ръководството за употреба и с всички други документи, предоставени заедно с този уред.

Също така, можете да намерите същата информация в базата данни на EPREL, като използвате връзката <https://eprel.ec.europa.eu> и наименованието на модела и серийния номер на продукта, които можете да намерите на табелката с технически данни на уреда.

За достъп до информация за вашия продукт в портала EPREL можете да сканирате кодовете по-долу:



Благодарим ви, че закупихте този продукт! Ако имате нужда от помощ във връзка с вашия продукт, посетете нашия уебсайт, като използвате връзките по-долу:

Получете ръководства за употреба: <https://www.heinner.ro>

Получете информация относно ремонтите: <https://www.heinner.ro>



Изхвърляне на отпадъците по начин, отговорен за околната среда

Можете да помогнете за опазването на околната среда!

Моля спазвайте местните разпоредби: Предайте нефункциониращото електрическо оборудване на център за събиране на отпадъци от електрическо оборудване.



HEINNER е регистрирана марка на компанията **Network One Distribution SRL**. Останалите търговски марки и наименованията на продуктите са търговски марки или регистрирани търговски марки на съответните им притежатели.

Нито една част от спецификациите не може да бъде възпроизвеждана под каквато и да е форма или средство, или използвана за получаване на производни като преводи, трансформации или адаптации, без предварителното съгласие на компанията NETWORK ONE DISTRIBUTION.

Copyright © 2013 Network One Distribution. Всички права запазени.

www.heinner.com, <http://www.nod.ro>

<http://www.heinner.com>, <http://www.nod.ro>



Този продукт е проектиран и произведен в съответствие със стандартите и нормите на Европейската общност.



Вносител: **Network One Distribution**

ул. Марчел Янку № 3-5, Букурещ, Румъния

Tel: +40 21 211 18 56, www.heinner.com, www.nod.ro

AUTOMATA MOSÓGÉP

Modell:
HWM-TL8013IVA++



- Automata mosógép
- Mosási kapacitás: 8 kg
- Energia hatékonysági osztály: A

HEINNER

1. BEVEZETÉS

Kérjük, figyelmesen olvassa el az utasításokat, és őrizze meg a kézikönyvet későbbi tanulmányozás céljából. A kézikönyv célja a készülék beszerelésével, használatával és karbantartásával kapcsolatos minden szükséges tudnivalót rendelkezésére bocsátani. A készülék helyes és biztonságos használata érdekében, kérjük, hogy beszerelés és használat előtt olvassa el figyelmesen a használati kézikönyvet.

2. AZ ÖN CSOMAGJÁNAK TARTALMA

- ➔ **Automata mosógép**
- ➔ **Használati kézikönyv**
- ➔ **Jótállási bizonylat**

3. BIZTONSÁGI FIGYELMEZTETÉSEK

Áramütés veszély!

A vészhelyzetek megelőzése érdekében, amennyiben a készülék tápkábele károsodás jeleit mutatja, annak cseréjét a gyártó, az általa jóváhagyott szervizek és műhelyek vagy szakirányú képzettséggel rendelkező személy végezhetik.

Kérjük, használja a készülékkel együtt szállított új tömlőket. A régi tömlők nem hasznosíthatók.

- Bármilyen jellegű karbantartási munkálat megkezdése előtt, kérjük, húzza ki a készülék tápkábelének dugaszát a villamoshálózat aljzatából.
- A berendezés minden egyes használata után kérjük, kapcsolja le a berendezést a hálózatról és zárja el a berendezés vízellátását is.
- A biztonságos használat érdekében a berendezés tápkábelének dugaszát hárompólusú, földeléssel ellátott hálózati aljzatba kell csatlakoztatni. Figyelmesen ellenőrizze és bizonyosodjon meg afelől, hogy az aljzat a földeléshez megfelelően van csatlakoztatva.
- Bizonyosodjon meg afelől, hogy a gyártó által előírt biztonsági utasításoknak, illetve a helyileg hatályos biztonsági előírásoknak megfelelően, a készüléknek a villamosenergia- és a vízhálózathoz történő csatlakoztatása szakképzett személy által történik.

Gyermekek esetleges sérüléséhez vezető veszélyforrás!

Ezt a berendezést 8 évnél idősebb gyermekek vagy korlátozott fizikai, érzékszervi és mentális képességekkel rendelkező személyek csak felügyelet alatt vagy annak rendeltetésszerű és biztonságos használatára irányuló kiképzés után használhatják, amennyiben annak használatával járó veszélyeket megértették. Gyermekek számára a berendezéssel játszani szigorúan tilos. A tisztítási és karbantartási műveleteket gyermekek csak felnőtt jelenlétében végezhetik.

3 év alatti gyerekek jelenlétében fokozottan figyeljen, hogy azok ne játszhassanak a készülékkel.

Bizonyosodjon meg afelől, hogy gyerekek vagy háziállatok nem kerültek a készülék belsejébe. Minden egyes használat előtt ellenőrizze a berendezést.

Gyermekek jelenlétében fokozottan figyeljen, hogy azok ne játszhassanak a készülékkel

A készülék használata során az üvegajtó magas hőmérsékletre is felforrósodhat. A működés során, amennyiben az nedves környezetben vagy robbanásveszélyes, gyúlékony vagy maró anyagok jelenlétében történik, ne engedjen gyermekeket vagy háziállatokat a készülék közelébe.

A berendezés üzembe helyezése előtt távolítsa el annak csomagolást, illetve szállításkor használt rögzítő csavarokat, ellenkező esetben ezek súlyos veszélyhelyzethez vezethetnek. A dugaszt a készülék üzembe helyezésekor könnyen hozzáférhetővé kell tenni.

Robbanásveszély!

Ne mosson és ne szárítson olyan darabokat, melyeket tűz- vagy robbanásveszélyes anyagokkal áztatott át (viasz, olajak, festékanyagok, benzin, zsírolajok, vegyiparban használatos oldószerek, kerozin, stb.), mivel fennáll a tűz keletkezésének és a robbanások kockázata. Mielőtt a mosógépbe helyezné, előzetesen kézzel alaposan öblítse át őket.

A készülék beszerelése:

A készüléket kizárólag beltéri használatra tervezték.

A berendezés nem használható beépített készülékként.

Ne tömítse el a berendezés nyílásait textilanyagokkal vagy egyéb tárgyakkal.

A mosógép elhelyezése nem javasolt nedves, valamint robbanékony gázok és maró hatású vegyi anyagok tárolására szánt helyiségekben.

Egyetlen bemeneti csővel felszerelt mosógépeket kizárólag hideg vízforrásra lehet csatlakoztatni. Kettős bemeneti csővel rendelkező mosógépeket hideg- és meleg vízforrásra egyaránt kell csatlakoztatni.

A dugaszt a készülék üzembe helyezésekor könnyen hozzáférhetővé kell tenni.

BIZTONSÁGRA VONATKOZÓ UTASÍTÁSOK

A berendezés üzembe helyezése előtt távolítsa el annak csomagolását, illetve a szállításkor rögzítő csavarokat, ellenkező esetben ezek súlyos veszélyhelyzethez vezethetnek.

A készülék károsodásához vezető veszélyforrások!

Az Ön mosógépét kizárólag háztartási célú felhasználásra tervezték és csak géppel mosható textilanyagok tisztítására használható.

- Ne mászon fel, illetve ne álljon és ne üljön rá a mosógép tetőlemezére.
- Ne támaszkodjon rá a mosógép ajtajára.
- A gép mozgatása során felmerülő veszélyek megelőzésére vonatkozó intézkedések:
 1. A szállításkor használatos rögzítő csavarok visszaszerelését csak szakember végezheti.
 2. A gép belső terében felgyűlt vizet le kell engedni a készülékből.
 3. Óvatosan mozgassa a készüléket. A berendezés emelése során ne annak kiálló részeit ragadja meg. A készülék mozgatása során ne használja a berendezés ajtaját fogantyúként.
 4. A készülék súlyos. Szállítását és mozgatását kellő figyelemmel végezze.

Az ajtó becsukásánál nem indokolt túlzott erő használata. Amennyiben az ajtó nehezen záródik, vizsgálja meg a behelyezett ruhamennyiséget vagy annak eloszlását.

A berendezés használata:

Mielőtt a készüléket első alkalommal használná mosásra, annak egy teljes mosási ciklust kell teljesítenie ruhák nélkül.

Tilos a robbanásveszélyes, gyúlékony vagy mérgező anyagok használata a mosásnál. A benzin és alkohol nem használható mosószerként. Kérjük, hogy a mosás során kizárólag a készülék számára előírt mosószereket használjon.

Mosás előtt, kérjük, ellenőrizze, hogy a ruhák zsebei üresek-e. Az olyan éles és szilárd tárgyak, mint a fémpenécek, kitűzők, szegek, csavarok és kődarabok súlyos meghibásodásokat okozhatnak.

A készülék ajtajának kinyitása előtt bizonyosodjon meg róla, hogy annak belsejéből az összes víz kiürült. Amennyiben a berendezés belsejében víz jelenlétét észleli, ne nyissa ki annak ajtaját.

Vigyázzon, hogy ne forrassa le magát, amikor a berendezésből a forró víz kifolyik.

A mosás során ne próbálja kézzel pótolni a vizet.

A mosási program befejezése után, kérjük, várjon két percet mielőtt a készülék ajtaját kinyitná.

4.

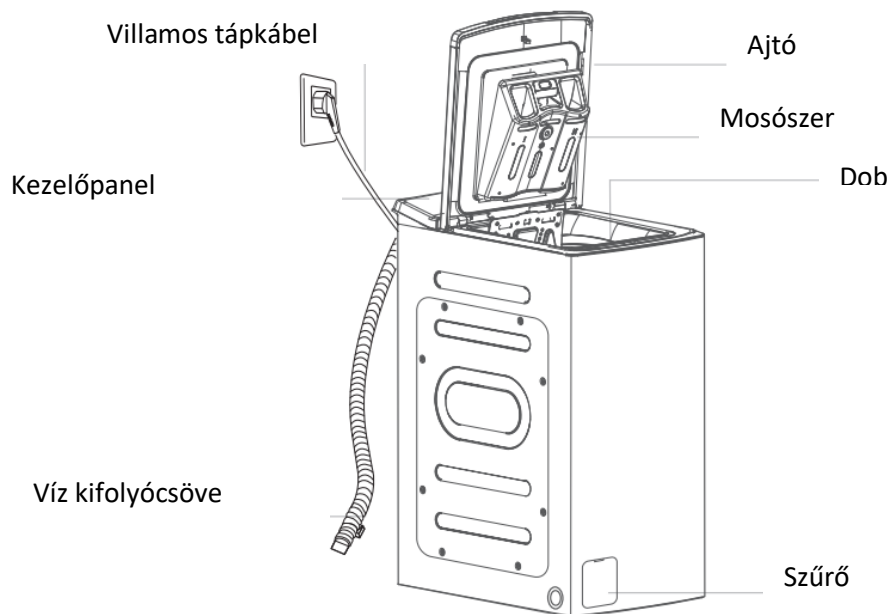

Tartozékok

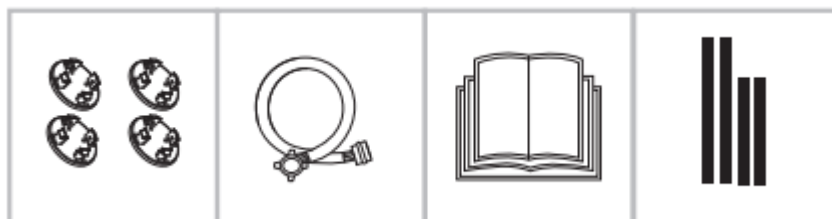

- 4x Szállítási védődugók
- 1x Hidegvíz befolyó csöve
- 1x Használati utasítás
- 1x Akusztikus szivacs

5. KEZELŐPANEL

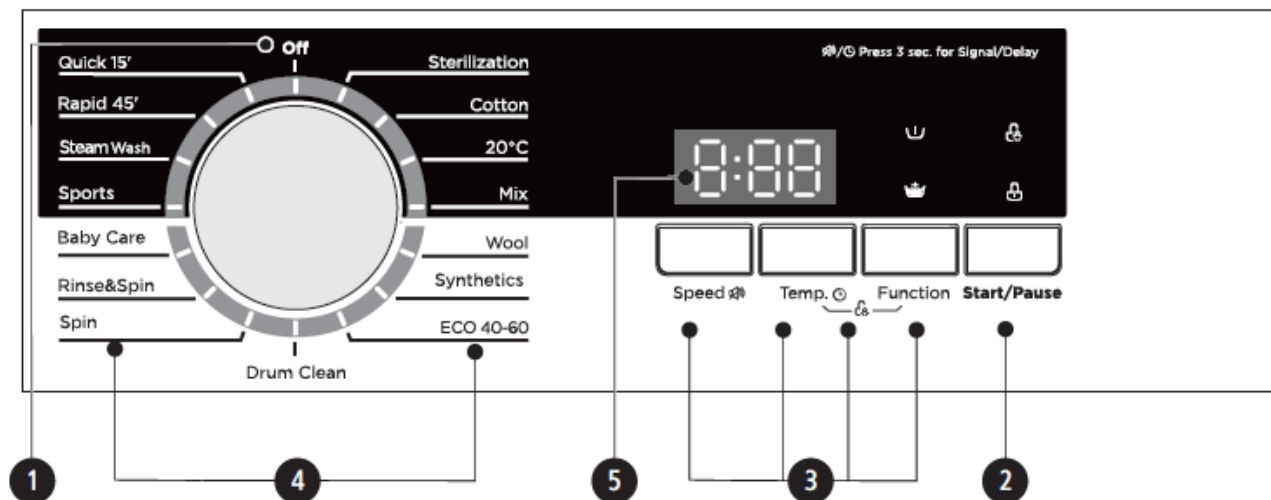

1. On/Off (Bekapcsolás/Kikapcsolás)

A mosógép ki- és bekapcsolására szolgáló gomb.

2. Start/Pause (Indítás/Megszakítás)

A kiválasztott mosási program elindítására/megszakítására szolgáló gomb.

3. Opciók

Ezek a gombok teszik lehetővé a további funkciók kiválasztását.

4. Programok

A mosandó ruhák függvényében választható programok.

5. Kijelző

A kijelző megjeleníti a beállításokat, a kiválasztott program végéig hátralevő időt, az aktív opciókat és a mosógép állapotára vonatkozó üzeneteket.

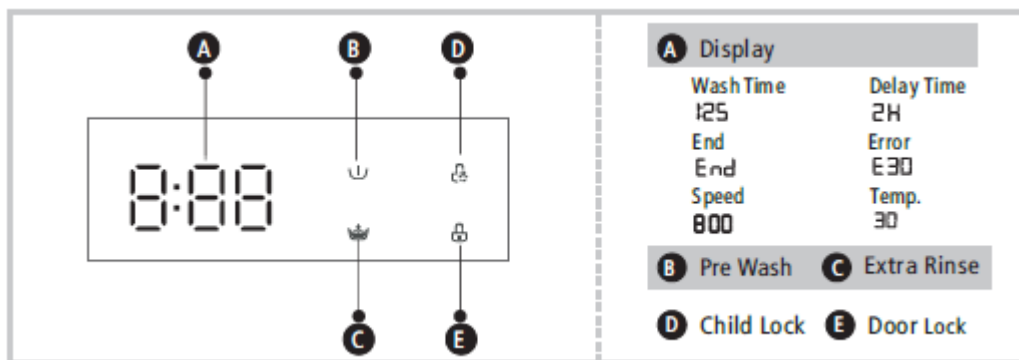

A- Kijelző

B- Előmosás

C- Extra öblítés

D- Gyerekzár

E- Ajtózár

6. TELEPÍTÉS

A beszerelés helye

A berendezés stabilitása elsődleges kérdés annak érdekében, hogy a berendezésnek a működés során történő mozgását megelőzhessük.

Bizonyosodjon meg afelől, hogy a készülék nem a villamos tápkábelben fekszik.

Mielőtt a készüléket beszerelné, olyan helyet válasszon neki, amely az alábbi sajátosságokkal rendelkezik:

1. Kemény, egyenletesen sima és száraz tartófelülettel rendelkezik.
2. Nincs kitéve közvetlenül napfény hatásának.
3. Bizonyosodjon meg róla, hogy a hely megfelelően szellőztethető.
4. A helyiség hőmérséklete mindig meghaladja a 0 °C értéket.
5. Ne helyezze olyan közvetlen hőforrások közelébe, mint amilyenek a szén- vagy gáz üzemanyaggal működő fűtőtestek.

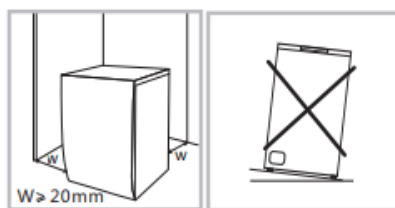

A mosógép kicsomagolása

- A csomagolóanyagok (pl. fóliák, hungarocell) veszélyesek lehetnek a gyermekek számára.
- Fennáll a fulladás veszélye!
- Minden csomagolóanyagot tartson gyermekektől távol.

1. Távolítsa el a kartondobozt és a hungarocell csomagolást.
2. Emelje fel a mosógépet és távolítsa el az alapcsomagolást. Ügyeljen arra, hogy a kis háromszög alakú habot úgy távolítsa el, hogy az alsó rész együtt legyen. Ha nem, fektesse le az egységet oldalfelületével, majd kézzel távolítsa el a kis habot az egység aljáról.
3. Távolítsa el a tápkábelt és a leeresztő tömlőt rögzítő szalagot.
4. Távolítsa el a bemeneti tömlőt a dobról. Ügyeljen arra, hogy a kis háromszög.



A szállítási rögzítő csavarok eltávolítása

A berendezés működésbe helyezése előtt elengedhetetlenül szükséges a készülék hátsó részébe szerelt szállító rögzítő csavarok eltávolítása.

Mivel a készülék szállítása esetén a rögzítő csavarokra szükség lehet, javasolt azoknak egy megfelelően biztonságos helyen történő tárolása.

Az alább felsorolt lépéseknek megfelelően járjon el:

1. Csavarkulcs segítségével először lazítsa ki, csavarja ki és távolítsa el mind a négy csavart.
2. A csavarhelyek nyílásait a tartozékként szállított védődugókkal zárja el.
3. Későbbi használat esetére őrizze meg a rögzítő csavarokat

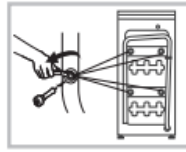

A mosógép stabilizálása

1. A négy láb anyacsavarjait szorítsa megfelelően a gépházra. Bizonyosodjon meg róla, hogy a lábakat megfelelően rögzítették a gépházhoz. Ellenkező esetben helyezze azokat az eredeti helyzetükbe, majd szorítsa meg az anyacsavarokat.
2. Lazítsa ki a rögzítő anyacsavarokat és addig forgassa a lábakat, amíg azok a padlót érintik.
3. Állítsa be a lábakat, majd bizonyosodjon meg róla, hogy a készülék stabilan áll.



Csatlakoztassa a vízellátó tömlőt

A szivárgás vagy vízkárok elkerülése érdekében kövesse az ebben a fejezetben található utasításokat.

- Ne törje meg, törje össze vagy módosítsa a vízbevezető tömlőt



Leeresztő tömlő

Ne hajlítsa meg vagy csavarja meg a kifolyót.

Szerelje fel megfelelően a vízkivezető csövet. Ellenkező esetben vízszivárgás okozta meghibásodások léphetnek fel.

A kifolyócső kétféleképpen szerelhető fel:

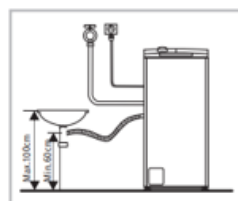
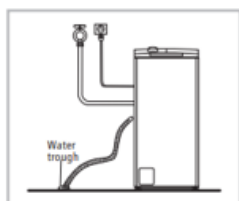

- Ha a gép rendelkezik leeresztő tömlőtartóval, kérjük, szerelje fel az alábbiak szerint.

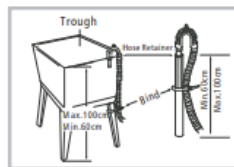
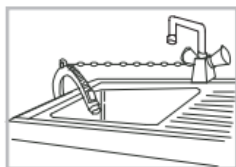

- A leeresztő tömlő felszerelésekor rögzítse megfelelően egy kötéllel
- Ha a leeresztő tömlő túl hosszú, ne erőltesse a mosógépbe, mert szokatlan zajokat fog kiváltani.

7. MŰVELET

Gyors indítás

Mielőtt üzembe helyezné a készüléket, bizonyosodjon meg annak megfelelő beszereléséről.

Mielőtt először mosna ruhákat, a gépnek előzetesen egy teljes mosási ciklust kell teljesítenie üresen, szennyes ruhák nélkül

Mosás előtt

- Az „I. esetben” mosószert kell hozzáadni, miután kiválasztotta az előmosást az ezzel a funkcióval rendelkező gépekhez.
- Győződjön meg arról, hogy a dob szárnyai megfelelően reteszelve vannak.

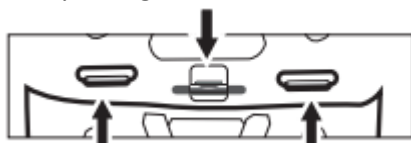

- Minden fémkampót megfelelően be kell akasztani a hátsó ajtófedél belsejébe.
- Ellenőrizze a hengert minden mosás előtt, simán kell gördülnie.

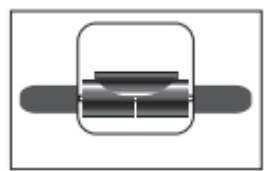

1. Csatlakoztassa
2. Nyissa ki a csapot
3. Betöltés
4. Adjon hozzá mosószert
5. Zárja be a dobot
6. Zárja be a gép dobját

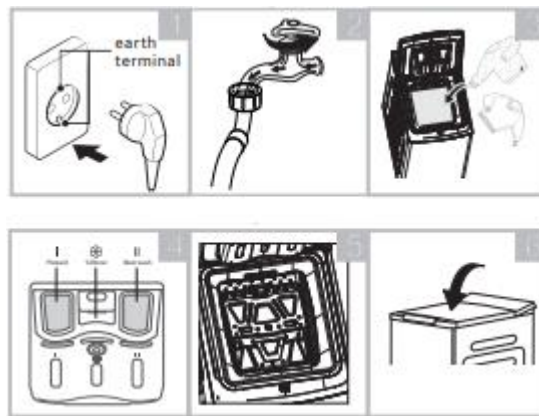

Mosás és mosás után



“End” a kijelzőn.

Minden mosás előtt

A mosógép működése során a környezet hőmérséklete legyen a 5-40°C értéktartományban. Amennyiben a készüléket egy olyan helyiségben tárolja, melynek hőmérséklete 0 °C vagy annál alacsonyabb, a készüléket át kell költöztetni egy olyan helyiségbe, ahol a felhasználó biztos lehet abban, hogy a víz be- és kifolyócsöve nem fagy be a készülék használata előtt.

Mosás előtt, kérjük, figyelmesen olvassa el a ruhák címkéin található és a mosószerre vonatkozó információkat. Használjon olyan habzásmentes vagy csökkentett habzású mosószereket, melyek a mosógép számára megfelelőek.

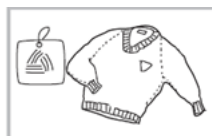

Olvassa el a ruha címkéjén feltüntetett információkat



Uritse ki teljesen a zsebeket



Kötözze össze a hosszú köteleket, húzza fel a cipzárokat és gombolja be a gombokat



Az apró mosnivalót helyezze egy párnahuzatba vagy egy kis mosószácba



Fordítsa ki azokat a ruhadarabokat, melyek könnyen pihesednek vagy hosszú szálakból készültek

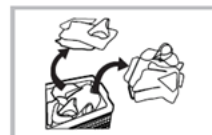

Válassza szét a különböző textiliákból készült ruhadarabokat

Mosószer tartó rekesz

- I Előmosószer számára fenntartott fiók
- II Mosószer számára fenntartott fiók
- ☼ Öblítőszer számára fenntartott fiók

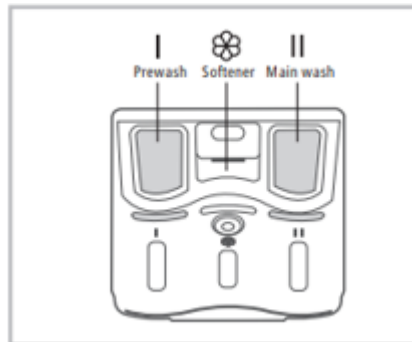

Program	I	II	☼	Program	I	II	☼
Sterilization		●	○	Spin			
Cotton	○	●	○	Rinse and spin			○
20 C	○	●	○	Baby care	○	●	○
Mix	○	●	○	Sports	○	●	○
Wool		●	○	Steam Wash	○	●	○
Synthetics	○	●	○	Rapid 45'		●	○
ECO 40-60		●	○	Quick 15'		●	○
Drum Clean							

- Kérjük, válassza ki a megfelelő típusú mosószert a maximális mosási teljesítmény és a minimális víz- és energiafogyasztás.
- A legjobb tisztítási eredmény eléréséhez fontos a megfelelő mosószer adagolás.
- Használjon csökkentett mennyiségű mosószert, ha a dob nincs teljesen feltöltve.
- A mosószer mennyiségét mindig a víz keménységéhez igazítsa, ha a csapvíz lágy, használja kevesebb mosószert.
- A ruhanemű szennyezettségének megfelelően adagolja, a kevésbé koszos ruhákhoz kevesebb mosószerre van szükség.
- Az erősen koncentrált (kompakt mosószer) különösen pontos adagolást igényel.









A következő tünetek a mosószer-túladagolás jelei:













- erős habképződés
- gyenge mosási és öblítési eredmény











A következő tünetek a mosószer adagolása alatti jelei:

- a ruhanemű megszürkül
- vízkőlerakódások a dobon, a fűtőelemen és/vagy a ruhaneműn

Ciklus	Névleges kapacitás	Ciklus időtartama	Energiafogyasztás Kwh/ciklusban	Vízfogyasztás Kwh/ciklus	Legmagasabb hőmérséklet (C)	Maradék nedvesség %/centrifugálási sebesség rpm-ben
Quick 15'	2.0	0:15	0.026	34	Hideg	70%/800
20C	4.0	1:01	0.183	47	20	70%/800
Cotton	8.0	2:45	1.394	71	60	53%/1300
Synthetics	4.0	2:20	0.625	44	40	70%/800
Mix	8.0	1:20	0.754	71	40	70%/800
ECO 40-60	8.0	3:38	0.739	57	-	53.9%/1250
	4.0	2:48	0.456	47	-	53.9%/1250
	2.0	2:48	0.196	38	-	53.9%/1250

Cotton	
Mosási hőmérséklet	40°C
Maximális száraz ruha mennyiség	8 kg
Centrifugálási sebesség kiválasztása (rpm)	1000
További funkciók	  
A program alapértelmezett időtartama	02:40
Ruhatípus/leírás	Hő és gyűrődésálló ruhadarabok, melyek pamutból vagy vászonszövetből készültek.
Synthetic	
Mosási hőmérséklet	40°C
Maximális száraz ruha mennyiség	4 kg
Centrifugálási sebesség kiválasztása (rpm)	1000
További funkciók	  
A program alapértelmezett időtartama	02:20
Ruhatípus/leírás	Szintetikus anyagokból készült ruhadarabok mosására ajánlott: blúzok, dzsekik, műszálas keverékek, stb. Kötöttáru mosása esetén a túlzott habképződés megelőzése érdekében csökkenteni kell a használandó mosószer mennyiségét
Baby Care	
Mosási hőmérséklet	60°C
Maximális száraz ruha mennyiség	8 kg
Centrifugálási sebesség kiválasztása (rpm)	1000
További funkciók	  
A program alapértelmezett időtartama	02:01
Ruhatípus/leírás	Ez a program kisbabák ruháinak mosására ajánlott, ezáltal biztosítva a babaruhák optimális tisztítása mellett azok hatékonyabb öblítését is, mely jobban kíméli a kicsik bőrét

Rapid 45'	
Mosási hőmérséklet	40°C
Maximális száraz ruha mennyiség	2 kg
Centrifugálási sebesség kiválasztása (rpm)	10001
További funkciók	 
A program alapértelmezett időtartama	00:45
Ruhatípus/leírás	Kevés és nem túl koszos ruha gyors kimosása.
Mix	
Mosási hőmérséklet	40°C
Maximális száraz ruha mennyiség	8 kg
Centrifugálási sebesség kiválasztása (rpm)	1000
További funkciók	  
A program alapértelmezett időtartama	01:20
Ruhatípus/leírás	Vegyes összetételű szennyes, pamutot és műszálas anyagot is tartalmaz.
20°C	
Mosási hőmérséklet	20°C
Maximális száraz ruha mennyiség	4 kg
Centrifugálási sebesség kiválasztása (rpm)	1000
További funkciók	  
A program alapértelmezett időtartama	01:01
Ruhatípus/leírás	Az élénk színű ruhák mosása jobban megvédi a színeket.
Sterilization	
Mosási hőmérséklet	70°C
Maximális száraz ruha mennyiség	4 kg
Centrifugálási sebesség kiválasztása (rpm)	1000
További funkciók	 
A program alapértelmezett időtartama	02:27
Ruhatípus/leírás	Tartsa a mosási hőmérsékletet 60 fok felett több mint 30 perc, hatékonyan távolítja el a káros baktériumokat
Quick 15'	
Mosási hőmérséklet	Cold
Maximális száraz ruha mennyiség	2 kg
Centrifugálási sebesség kiválasztása (rpm)	800
További funkciók	
A program alapértelmezett időtartama	00:15
Ruhatípus/leírás	Ez a program kiválóan megfelel kisebb mennyiségű és kevésbé szennyezett ruhák mosására.
Wool	
Mosási hőmérséklet	40°C
Maximális száraz ruha mennyiség	2 kg
Centrifugálási sebesség kiválasztása (rpm)	800
További funkciók	 
A program alapértelmezett időtartama	01:07
Ruhatípus/leírás	Olyan gyapjú ruhadarabok mosására alkalmas program, melyek kézi vagy gépi mosás útján tisztíthatók. Kímélő program, melyet az anyagnak a túlzott vízmennyiség következtében fellépő összemelésének megelőzése érdekében fejlesztettek ki

Spin Only	
Mosási hőmérséklet	--
Maximális száraz ruha mennyiség	8 kg
Centrifugálási sebesség kiválasztása (rpm)	1000
További funkciók	
A program alapértelmezett időtartama	00:12
Ruhatípus/leírás	Extra centrifugálás, kiegészítve a centrifugálási fordulatszám előzetes kiválasztásának lehetőségével.
Rinse & Spin	
Mosási hőmérséklet	--
Maximális száraz ruha mennyiség	8 kg
Centrifugálási sebesség kiválasztása (rpm)	1000
További funkciók	 
A program alapértelmezett időtartama	00:20
Ruhatípus/leírás	További öblítés, centrifugálással.
ECO 40-60	
Mosási hőmérséklet	--
Maximális száraz ruha mennyiség	8 kg
Centrifugálási sebesség kiválasztása (rpm)	1300
További funkciók	
A program alapértelmezett időtartama	03:38
Ruhatípus/leírás	Élénk színű ruhákat mosva jobban védi a színeket. Alapértelmezett 40 C, nem választható, kb. 40 C - 60 C közötti mosásra alkalmas
Drum Clean	
Mosási hőmérséklet	90°C
Maximális száraz ruha mennyiség	-
Centrifugálási sebesség kiválasztása (rpm)	1000
További funkciók	
A program alapértelmezett időtartama	01:18
Ruhatípus/leírás	Speciálisan beállítva ebben a gépben a dob és a cső tisztítására. 90 °C-os magas hőmérsékletű sterilizálást alkalmaz, hogy zöldebbé tegye a mosandó ruhákat. A program végrehajtásakor a ruhákat vagy egyéb mosószereket nem lehet hozzáadni. Ha megfelelő mennyiségű klóros fehérítőszert visz be, a hordótisztító hatás jobb lesz. Az ügyfél ezt a programot igény szerint rendszeresen használhatja.
Steam Wash	
Mosási hőmérséklet	40°C
Maximális száraz ruha mennyiség	2.5 kg
Centrifugálási sebesség kiválasztása (rpm)	800
További funkciók	  
A program alapértelmezett időtartama	01:48
Ruhatípus/leírás	A gőzmosó mélyen behatol a szálakba, ami hatékonyan a baktériumokat és a baktériumokat, megakadályozza a szagok kialakulását és megvédi az egészséget.
Sports	
Mosási hőmérséklet	20°C
Maximális száraz ruha mennyiség	4 kg
Centrifugálási sebesség kiválasztása (rpm)	1000
További funkciók	  
A program alapértelmezett időtartama	00:45
Ruhatípus/leírás	Az aktív ruha mosása.



Forgási sebesség

Szükség esetén a centrifugálási sebesség a Speed gomb megnyomásával állítható a következő lépésekben: 0-400-600-800-1000-1200-1300



Időzítés

A mosógép beindítási időpontjának beállítása:

1. Válasszon ki egy programot
2. Nyomja le a Delay (Időzítés) gombot az indítás késleltetési idejének beállítása érdekében (Az időzítés tartama 0-24H közötti tartományban állítható.)
3. Nyomja le a [Start/Pause] gombot az indítás időzítési funkció aktiválásához.



Az indítás időzítési funkció aktiválásának visszavonása:

Tartsa lenyomva a [Delay] gombot egészen addig, amíg a kijelzőn a 0H üzenet jelenik meg. Ezt még a program elkezdése előtt le kell nyomni. Amennyiben a program már elindult, nyomja le az [On/Off] gombot a program újbóli beállítása céljából.



Pre Wash (Előmosás)

Ez a program teszi lehetővé a főmosási program előtt a ruhák előmosását. Amikor ezt a funkciót választja, indítás előtt szükséges, hogy a rekesz I fiókjába is tegyen mosószert



Extra Rinse (További áztatás)

Ennek a funkciónak a kiválasztása a ruhák extra áztatását teszi lehetővé.



Hőmérséklet beállítása

A hőmérséklet értékének beállítására szolgáló gomb (20°C, 30°C, 40°C, 60°C, 90°C).



Gyerekszár

A gyermekek hibás működésének elkerülése érdekében.



Nyomja meg egyszerre a [Temp] és a [Function] gombot 3 másodpercig, amíg a berregő sípol. A gyerekszár jelzőfénye bekapcsol.

VIGYÁZAT.

Bármely másik gomb megnyomására a Gyerekszár jelzőfény 3 másodpercig villogni kezd.

A Gyerekszár kikapcsolja az összes gomb funkcióját, kivéve a Gyerekszár gombot! Csak a két [Temp.] és [Function] gomb egyidejű megnyomásával kapcsolható ki a gyerekszár! Kérjük, kapcsolja ki a Gyerekszárát, mielőtt új programot választ!



A hangjelző némítása

Válassza ki a programot.

Nyomja meg a [Speed] gombot 3 másodpercig, a hangjelzés elnémul.

A csengő funkció aktiválásához nyomja meg ismét a gombot 3 másodpercig. A beállítás a következő visszaállításig megmarad



8. KARBANTARTÁS

Tisztítás és karbantartás

A karbantartási munkálatok megkezdése előtt kérjük, hogy kapcsolja le a készüléket a villamos-energia hálózatról, valamint zárja el a vízcsapot is.

A mosógép tartályának tisztítása

A tartály belsejében fémdarabok által hátrahagyott rozsdamaradékokat azonnali hatállyal klórmentes mosószerrel kell eltávolítani. Ne használjon fémszivacsokat.

A tartály tisztítása közben ne helyezzen ruhákat annak belsejébe.

Az ajtó tömítéseinek és ablakának tisztítása

Az ajtó tömítéseiről és ablakáról minden mosás után le kell tisztítani a foltokat és szőszlerakódásokat. A szőszök összecsomósodása vízszivárgásokhoz vezethet. Minden mosás után távolítsa el a tömítésben felgyűlt tárgyakat, pénzérméket, gombokat

A víz befolyó szűrőjének tisztítása

A befolyó szűrő tisztítása akkor szükséges, ha a mosáshoz szükséges vízmennyiség csökken.

A szűrő tisztítása a csappal való csatlakozásnál:

1. Zárja el a csapot.
2. Csatlakoztassa le a csapról a befolyócsövet.
3. Tisztítsa ki a szűrőt.
4. Csatlakoztassa vissza a csapra a befolyócsövet.

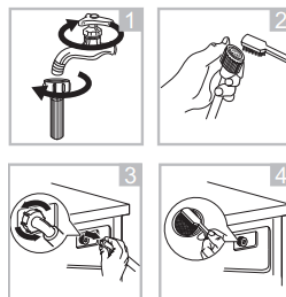

A szűrő tisztítása a mosógéppel való csatlakozásnál:

1. Csavarozza le a mosógép hátsó részén található befolyócsövet.
2. Emelje ki a szűrőt egy hosszú csőrű fogó segítségével és takarítás után helyezze vissza.
3. A szűrő tisztításához használjon keféket.
4. Csatlakoztassa vissza a befolyócsövet



A kifolyó pumpához tartozó szűrő tisztítása

1. Vigyázzon a forró vízzel!
2. Az áramütés elkerülése érdekében a szűrő tisztítása közben húzza ki a készülék dugaszát a

villamosenergia hálózathoz.

3. A kifolyó pumpájának szűrője mosás közben visszatarthatja az apró tárgyakat. A mosógép megfelelő működésének érdekében időszakosan tisztítsa ki a szűrőt

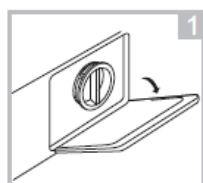

Nyissa le az alsó részen található védőlemez

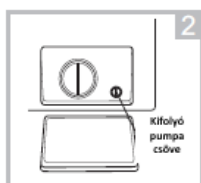

Fordítsa el 90 fokkal, húzza ki a csövet, majd húzza ki annak dugóját



A víz kifolyása után helyezze vissza a csövet



Oramutató járásával ellentétes irányba csavarva távolítsa el a szűrőt



Távolítsa el belőle az idegen testeket

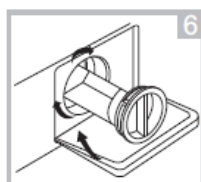

Csavarja vissza a szűrőt és zárja vissza az alsó részen található védőlemez

9. HIBAE LHÁRÍTÁS

Hibaelhárítás

Amennyiben a készülék nem indul el, vagy megáll működés közben, először próbálkozzon a meghibásodásnak az alábbi táblázatban foglaltak szerinti azonosításával és elhárításával, és amennyiben nem jár sikerrel, vegye igénybe egy szerviz szolgáltatásait.

Leírás	Okok	Elhárítási javaslatok
A mosógép nem indul el	Az ajtó nincs jól bezárva	Az ajtó bezárása után indítsa be újra a mosógépet Vigyázzon, hogy a ruhák ne akadályozzák az ajtó zárását
Az ajtót nem lehet kinyitni	A készülék biztonsági rendszere aktiválódott	Az áramellátást szakítsa meg, majd kapcsolja vissza
Vízszivárgások	A be- vagy kifolyó cső csatlakoztatásai nincsenek megfelelően megszorítva	Ellenőrizze és szorítsa meg a csatlakoztatásokat. A kifolyó csövet tisztítsa ki.
A rekeszben mosószer maradványok vannak	A mosószer nedves lett vagy megcsomósodott	A mosószeres rekeszt tisztítsa ki, majd törölje ki
A fényjelzések vagy a kijelző nem működnek	Villamosenergia ellátási problémák	Ellenőrizze a berendezés áramellátását és a dugasz csatlakozását
Szokatlan zajok		Bizonyosodjon meg róla, hogy a szállítócsavarokat eltávolították, valamint arról, hogy a mosógép tartófelülete sima, szilárd és a gép stabilan áll rajta

Az ellenőrzés elvégzése után indítsa el a mosógépet. Amennyiben a probléma ismételt jelentkezik vagy a kijelzőn más hibajelzések is megjelennek, forduljon egy szervizhez.

FONTOS LÉPÉSEK A KÉSZÜLÉK MOZGATÁSA ESETÉN

Leírás	Okok	Elhárítási javaslatok
E30	Az ajtó nincs jól bezárva	Az ajtó bezárása után indítsa újra a mosógépet. Vigyázzon, hogy a ruhák ne akadályozzák az ajtó zárását
E10	Mosás közben felmerülő vízellátási problémák	Bizonyosodjon meg róla, hogy a befolyó víz nyomása nem túl alacsony Egyenesítse ki a víz befolyó csövét Bizonyosodjon meg róla, hogy a szűrő nem dugult el
E21	A víz leeresztése a készülékből nem megfelelő	Bizonyosodjon meg róla, hogy a kifolyó szűrője nem dugult el
E12	Túl nagy a víz mennyisége	Indítsa újra a készüléket
EXX	Egyebek	Végezze el az összes szükséges ellenőrzést, majd forduljon egy szervizhez.

- Ellenőrizze, hogy az ajtó és a mosószer-adagoló megfelelően be van-e zárva.
- Távolítsa el a vízbevezető csövet és a kimeneti tömlőt a ház szerelvényeiről.
- Hagyja, hogy a víz teljesen kifolyjon a készülékből
- Fontos: Helyezze vissza a 4 szállítócsavart a készülék hátuljába.
- Ez a készülék nehéz.

Szállítás körülményein.

Emelés közben soha ne fogja meg a gép kiálló részét.

A gépajtó nem használható kilincsként.

MŰSZAKI ADATOK

A termék műszaki adatai a készülék műszaki adattábláján és az energiacímkéjén vannak feltüntetve.

A hűtőszekrény energiacímkéjén található QR-kód egy internetes linket biztosít a készülék teljesítményével kapcsolatos információkhoz, melyek az EPREL adatbázisban találhatóak.

Utólagos tanulmányozás céljából, őrizze meg az energiacímkét a használati útmutatóval valamint a készülék egyéb dokumentumaival együtt.

Úgyisint, ezeket az információkat az EPREL adatbázisban is megtalálja. Ennek érdekében használja a következő linket: <https://eprel.ec.europa.eu> és adja meg a termék megnevezését és sorozatszámát, amelyeket a készülék műszaki adattábláján talál.

A termékével kapcsolatos információk eléréséhez az EPREL portálon beolvashatja az alábbi kódokat:



Köszönjük, hogy termékünket választotta! Ha termékével kapcsolatosan további információkra van szüksége, keresse fel honlapunkat az alábbi linkeket használva:

A használati útmutatókat innen töltheti le: <https://www.heinner.ro>

A javításokra vonatkozó adatokat itt találja: <https://www.heinner.ro>



A hulladékok környezetfelelős eltávolítása

Segíthet a környezet védelmében!

Kérjük, tartsa be a helyi rendelkezéseket: a nem működő elektromos berendezéseket a használt elektromos hulladékokat gyűjtő központba szolgáltatassa be.



A HEINNER a **Network One Distribution SRL(KFT)** társaság által bejegyzett védjegy. A többi márkajelzés és a termékek megnevezése kereskedelmi vagy az illető birtoklók által bejegyzett márkanevek.

A műszaki leírások egyik része sem reprodukálható semmilyen formában és semmilyen módon, és nem használható fel fordításra, átváltoztatásra vagy alkalmazásra a NETWORK ONE DISTRIBUTION társaság előzetes beleegyezése nélkül.

Copyright © 2013 Network One Distribution. Minden jog fenntartva.

www.heinner.com, <http://www.nod.ro>

<http://www.heinner.com>, <http://www.nod.ro>



A terméket az Európai Közösség előírásainak és jogszabályainak megfelelően tervezték és gyártották.



Importator: **Network One Distribution**

Str. Marcel Iancu, nr. 3-5, București, România

Tel: +40 21 211 18 56, www.heinner.com , www.nod.ro